



Husqvarna®



SOLUZIONI PER L'EDILIZIA 2023
CONSTRUCTION PRODUCTS



1689 - Fondazione di Huskvarna fabbrica armi



1872 - Macchine da cucire (fino al 1997)



1874 - Accessori da cucina



1896 - Biciclette (fino al 1962)



1903 - Motociclette (fino al 1987)



1918 - Tosa erba



1958 - Mototroncatori



1959 - Motoseghe



1959 - Primo tosa erba per la grande distribuzione

1985 - Trattorino rasa erba



1978 - Parte di Electrolux

1987 - Taglio ad anello



1978 - Acquisizione



1969 - Sistemi antivibranti



1973 - Blocco catena automatico



1979 - Acquisizione



1988 - Acquisizione American Yard Products

1995 - Robot rasa erba solare



1989 - Iniezione aria



2002 - Acquisizione



2006 - Scorporazione Electrolux Quotazione in borsa



2007 - Acquisizione



1998 - Robot rasa erba automatico



2007 - Cut-n-Break

2012 - Batterie



2009 - Acquisizione King Concepts



2009 - Robot da demolizione



2008 - Unificazione brand per prodotti edilizia



2014



2017 - Acquisizione Pullman-Ermator



2017 - Acquisizione HTC Flooring System



2017 - Acquisizione compattazione leggera da Atlas Copco



2022 - Acquisizione Blastrac



...e in futuro molto altro ancora!



PACE 2022 - Linea batteria



Inquadra con il tuo cellulare il QR code per scaricare gli esplosi.

INDICE

TAGLIO E FORATURA

Carotatrici	5
Mototroncatrici	10
Tagliasuolo	20

COMPATTAZIONE

Compattatrici	24
---------------------	----

PREPARAZIONE DELLE SUPERFICI

Levigatrici	30
Stripper	35
Scarificatrici	36

POSA DEL CEMENTO

Frattezzatrici	39
Vibratori per calcestruzzo	45
Stagge vibranti	46

GESTIONE POLVERI E FANGHI

Depuratori d'aria	40
Aspiratori di polveri	41
Aspiratori di liquidi e fanghi	44

ULTERIORI ACCESSORI	47
---------------------------	----

UTENSILI DIAMANTATI

Dischi diamantati	50
Catene diamantate	57
Mole diamantate	58
Foretti diamantati	62
Placchette diamantate	69



+39 331 134 9323

Contatta su Whatsapp
il tuo assistente digitale.

SERVICE KIT

L'assistenza e la manutenzione delle macchine Husqvarna con i ricambi originali prolungano il ciclo di vita e migliorano le prestazioni. I nostri nuovi kit di manutenzione contengono i ricambi più comunemente utilizzati che devono essere controllati e sostituiti periodicamente.

**Risparmia fino al 40%
sui tuoi tagliandi**



HUSQVARNA FLEET SERVICES™

Connetti la tua flotta per avere il pieno controllo:

- Gestione dell'inventario
- Ubicazione delle macchine
- Statistiche sull'utilizzo della macchina (ore di utilizzo e regime)
- Panoramica della manutenzione con notifiche

Il sensore si adatta alle attrezzature di qualsiasi marchio.



DM 220

966563501

CAROTAGGIO MANUALE
O A COLONNA



Potenza	1.85 kW
Tensione	230 V
Velocità dell'albero a pieno carico	580/1.400/2.900 giri/min.
Filettatura interna dell'albero	G 1/2"
Filettatura esterna dell'albero	1 1/4 7 UNC
Diametro foretto con telaio/manuale, max	150/80 mm
Peso	7 kg

Completo di utensili dedicati

Optional:

telaio DS 250

aspiratori di polveri S 11, DE 110 H

aspiratori di liquidi e fanghi W 70 P o W 250 P

tanica dell'acqua WT 15i o WT 2 GO

anelli per fanghi



Per la selezione dell'utensile diamantato
vedere pag. 72

HUSQVARNA
SERVICE
CONTRACTS

DM 230

968411001

CAROTAGGIO
MANUALE



Potenza	1.85 kW
Tensione	230 V
Velocità dell'albero a pieno carico	580/1.400/2.900 giri/min.
Filettatura interna dell'albero	1 / 2"
Filettatura esterna dell'albero	1 1/4" 7 UNC
Diametro foretto con telaio/manuale max	150/80 mm
Peso	7 kg

Completo di utensili dedicati

Optional:

telaio DS 150 o DS 250

aspiratori di polveri DE 110 H o DE 120 H

aspiratori di liquidi e fanghi W 70 P o W 250 P

tanica dell'acqua WT 15i o WT 2 GO

anelli per fanghi



Per la selezione dell'utensile diamantato
vedere pag. 72

HUSQVARNA
SERVICE
CONTRACTS

DM 400

967910301



CAROTAGGIO
A COLONNA



Potenza	3.2 kW
Tensione	230 V
Velocità albero a pieno carico	230/460/720 giri/min
Filettatura esterna dell'albero	1 1/4" 7 UNC
Diametro foretto con telaio, max	950 mm
Peso	14 kg

Completo di utensili dedicati

Optional:
telaio DS 500
telaio DS 50 Gyro
aspiratori di liquidi e fanghi W 70 P o W 250 P
tanica dell'acqua WT 15i o WT 2 G0
anelli per fanghi



Per la selezione dell'utensile diamantato
vedere pag. 72

HUSQVARNA
SERVICE
CONTRACTS

DM 540 i KIT

970493703

CAROTAGGIO MANUALE
O A COLONNA



Potenza	1,4 kW
Motore	BLDC (Brushless 36 V)
Alimentazione	Batteria
Velocità albero senza carico, max	4.450 giri/min.
Diametro foretto con telaio manuale max	100/75 mm
Peso (motore + batteria)	4,9 + 1,9 kg

Compresi nel kit : 2 batterie Bli 300,
caricabatterie QC 500

Optional:

telaio DS 150
aspiratore di liquidi e fanghi W 70 P o W 250 P
aspiratore di polveri S 11 o DE 110 i H
ulteriori batterie BLi 200 - BLi 300
anelli per fanghi
tanica dell'acqua WT 15i o WT 2 G0



Per la selezione dell'utensile diamantato
vedere pag. 72



DM 700

970449401



CAROTAGGIO
A COLONNA

Potenza	3 - 6 kW
Tensione (Collegato a 230 - 400V)	230 - 400 V
Velocità dell'albero a pieno carico	113/608 giri/min.
Filettatura esterna dell'albero	1 1/4" 7 UNC
Diametro foretto con telaio, max	600 mm
Peso motore	14 kg

Completo di utensili dedicati

Optional:

- telaio DS 900
- gruppi di potenza PP 70 o PP 220 o PP 492
- aspiratori di liquidi e fanghi W 70 o W 250 P
- anelli per fanghi



Per la selezione dell'utensile diamantato
vedere pag. 72

HUSQVARNA
SERVICE
CONTRACTS



K 770

967682101

TAGLIO
MANUALE



Potenza	3,7 kW
Motore	Motore a 2 tempi, raffreddato ad aria
Cilindrata	74 cc
Diametro del disco diamantato	350 mm
Profondità di taglio, max	125 mm
Peso (senza carburante e disco di taglio)	10,1 kg

Completo di utensili dedicati

Optional:
carrello KV 7
tanica dell'acqua WT 15i o WT 2 G0

Disponibile anche in versione Smartguard



Per la selezione dell'utensile diamantato
vedere da pag. 50



K 970 16"

967348101

TAGLIO
MANUALE

Potenza	4,8 kW
Motore	Motore a 2 tempi, raffreddato ad aria
Cilindrata	94 cc
Diametro del disco diamantato	400 mm
Profondità di taglio, max	155 mm
Peso senza carburante e disco di taglio	11,6 kg

Completo di utensili dedicati

Optional:
carrello KV 9/12
tanica dell'acqua WT 15 i o WT 2 GO

Disponibile anche in versione Smartguard



Per la selezione dell'utensile diamantato
vedere da pag. 50

**HUSQVARNA
SERVICE
CONTRACTS**

K 970 Ring 14"

967272301

TAGLIO
MANUALE

Potenza	4,8 kW
Motore	Motore a 2 tempi, raffreddato ad aria
Cilindrata	94 cc
Diametro del disco diamantato	370 mm
Profondità di taglio, max	270 mm
Peso (senza carburante e disco di taglio)	13,8 kg

n° 2 dischi diamantati ELITE-RING R1400
diametro 370 mm
oppure
n° 3 dischi diamantati VARI-RING R800
diametro 370 mm
n. 1 coppia di rulli di ricambio
cassa in legno per il trasporto

Optional:
morsa per tubi
tanica dell'acqua WT 2 GO



Per la selezione dell'utensile diamantato
vedere da pag. 50



**HUSQVARNA
SERVICE
CONTRACTS**



K 4000

967079801



TAGLIO
MANUALE

Potenza nominale	2.7 kW
Motore	Elettrico 230 V
Diametro del disco diamantato	350 mm
Profondità di taglio, max	125 mm
Peso (escluso cavo e disco di taglio)	7,6 kg

Completo di utensili dedicati

Optional:
tanica dell'acqua WT 15i o WT 2 GO
forcella VAC per utilizzo a secco
aspiratore DE 110 H



Per la selezione dell'utensile diamantato
vedere da pag. 50

**HUSQVARNA
SERVICE
CONTRACTS**

K 4000 Cut-n-Break

967079701

TAGLIO
IN PROFONDITÀ



Potenza	2.7 kW
Motore	Elettrico 230 V
Diametro del disco diamantato	230 mm
Profondità di taglio max	400 mm
Peso (escluso cavo e disco di taglio)	8,4 kg

completa di n. 1 coppia di dischi diamantati
ELITE-CUT EL10 CNB

Optional:
tanica dell'acqua WT 15i o WT 2 G0



Per la selezione dell'utensile diamantato
vedere da pag. 50



HUSQVARNA
SERVICE
CONTRACTS

MOTOTRONCATRICE PRIME

K 7000 Chain

970449701



ATTREZZATURA
AD ALTA FREQUENZA

Potenza trifase/monofase	5,5/3 kW
Motore	Elettrico Alta frequenza
Catena diamantata	450 mm
Profondità di taglio max	450 mm
Peso (escluso cavo)	9,1 kg

n° 1 catena diamantata Elite-Cut C20
profondità di taglio utile 450 mm



Optional:

morsa per tubi
gruppo di potenza PP 70
tanica dell'acqua WT 15i o WT 2 GO



Per la selezione dell'utensile diamantato
vedere da pag. 67

**HUSQVARNA
SERVICE
CONTRACTS**



MOTOTRONCATRICE PRIME

K 7000

970449601



ATTREZZATURA
AD ALTA FREQUENZA

Potenza trifase/monofase	5,5/3 kW
Motore	Elettrico Alta frequenza
Diametro disco diamantato	400 mm
Profondità di taglio, max	155 mm
Peso (escluso cavo e disco)	9,8 kg

Completo di utensili dedicati



Optional
centralina PP 70
centralina PP 220



Per la selezione dell'utensile diamantato
vedere da pag. 50

**HUSQVARNA
SERVICE
CONTRACTS**

MOTOTRONCATRICE PRIME



K 7000 Ring 17"

970449901

ATTREZZATURA
AD ALTA FREQUENZA

Potenza trifase/monofase	5,5/3 kW
Motore	Elettrico Alta frequenza
Diametro disco diamantato	425 mm
Profondità di taglio, max	325 mm
Peso (escluso cavo e disco)	12,4 kg

n° 2 dischi diamantati ELITE-RING R 1400
diametro 425 mm
n. 1 coppia di rulli di ricambio

Optional:

morsa per tubi
binario WA 20
gruppi di potenza PP 70 o PP 220



Per la selezione dell'utensile diamantato
vedere da pag. 50

HUSQVARNA
SERVICE
CONTRACTS

K1 PACE 14"

970546705



TAGLIO MANUALE

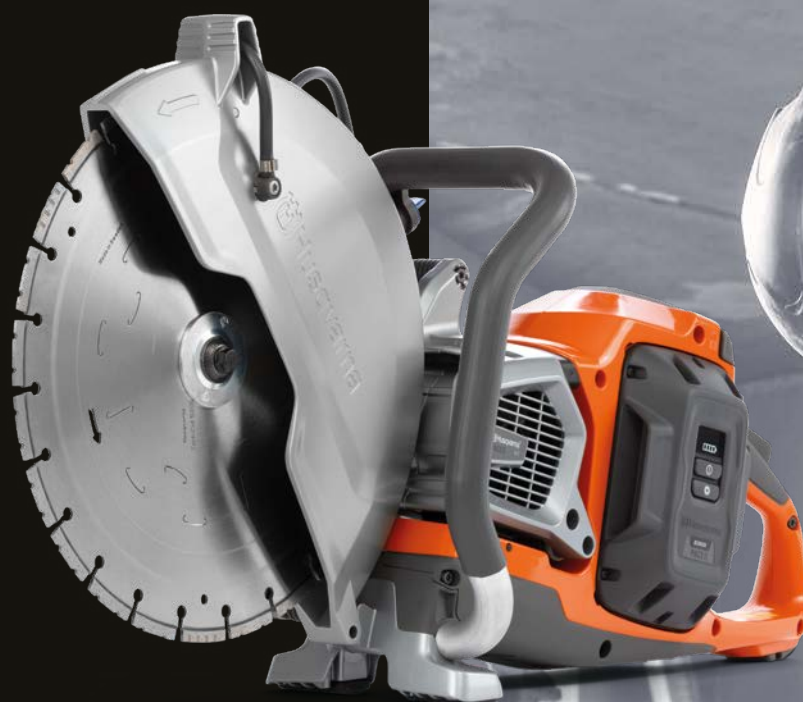

Motore	BLDC (Brushless)
--------	---------------------

Alimentazione	Batteria PACE 94 V
---------------	--------------------

Diametro disco diamantato	350 mm
---------------------------	--------

Profondità di taglio max	145 mm
--------------------------	--------

Peso (esclusa batteria e disco)	7,4 kg
---------------------------------	--------

Compresi nel kit : 2 batterie B 380 X e caricabatterie C 900 X, 1 disco Tacti-Cut Bat 350 mm

Optional:

forcella contenimento polveri

aspiratore DE 120 H PACE

tanica dell'acqua WT 15i o WT 2 GO



Per la selezione dell'utensile diamantato vedere da pag. 50



K 535 i

967795901



TAGLIO MANUALE



Motore	BLDC (Brushless)
Alimentazione	Batteria PACE 94 V
Diametro disco diamantato	230 mm
Profondità di taglio	76 mm
Peso (esclusa batteria e disco)	3,5 kg

Mototroncatrice fornita senza batteria e caricatore

Optional:

Attacco VAC
aspiratore di polveri DE 110i H
tanica dell'acqua WT 15i o WT 2 G0



Per la selezione dell'utensile diamantato
vedere da pag. 50



HUSQVARNA
SERVICE
CONTRACTS



FS 305

965150026

MACCHINE TAGLIASUOLO

Potenza	3,6 kW
Motore	Honda
Alimentazione	Benzina
Diametro disco diamantato, max	350 mm
Profondità di taglio, max	125 mm
Peso	54 kg

* Dati forniti dal produttore del motore.

Completo di utensili dedicati



Per la selezione dell'utensile diamantato vedere da pag. 50

FS 309

96767830

MACCHINE TAGLIASUOLO

Potenza	6,3 kW
Motore	Honda
Alimentazione	Benzina
Diametro disco diamantato, max	350 mm
Profondità di taglio max	122 mm
Peso	64 kg

* Dati forniti dal produttore del motore.

Completo di utensili dedicati



Per la selezione dell'utensile diamantato vedere da pag. 50



FS 410 D

965150116

MACCHINE
TAGLIASUOLO

Potenza	6,8 kW
Motore	YANMAR
Alimentazione	Diesel
Diametro disco diamantato, max	500 mm
Profondità di taglio, max	189 mm
Peso	165 kg

Completo di utensili dedicati



Per la selezione dell'utensile diamantato
vedere da pag. 50

HUSQVARNA
SERVICE
CONTRACTS

FS 400 LV

967796501

MACCHINE TAGLIASUOLO

Potenza	8,7 kW
Motore	HONDA
Alimentazione	benzina
Diametro disco diamantato, max	500 mm
Profondità di taglio, max	187 mm
Peso	100 kg

* Dati forniti dal produttore del motore.

Completo di utensili dedicati

Disponibile anche versione motore KOHLER benzina



Per la selezione dell'utensile diamantato
vedere da pag. 50

HUSQVARNA
SERVICE
CONTRACTS

FS 524

967046102

MACCHINE TAGLIASUOLO

Potenza	15,5 kW
Motore	HONDA
Alimentazione	benzina
Diametro disco diamantato, max	600 mm
Profondità di taglio, max	247 mm
Peso	239 kg

Compreso 1 disco ELITE - CUT 600 mm



Per la selezione dell'utensile diamantato
vedere da pag. 50

LF 75 LAT

967854902

COMPATTAZIONE LEGGERA
PIASTRA FRONTALE



Potenza	3,6 kW
Motore	Honda GX160
Alimentazione	Benzina
Larghezza piastra	500 mm
Peso	97 kg
Impugnatura antivibrante brevettata	
Ruote di trasporto	
Sistema brevettato di distribuzione acqua	

Optional:

dispositivo di sollevamento con carrello elevatore
kit per pavimentazione in blocchi (Vulcolan)



HUSQVARNA
SERVICE
CONTRACTS

LF_e 60 LAT

970516901



COMPATTAZIONE LEGGERA
PIASTRA FRONTALE

Potenza	1,8 kW
Motore	Honda EGX
Alimentazione	Batteria
Larghezza piastra	350 mm
Peso	88 kg

Compreso di utensili dedicati



LG 164

967855602 (350mm)

967855601 (450mm)

COMPATTAZIONE LEGGERA
PIASTRA REVERSIBILE

Potenza	3,6 kW
Motore	Honda GX 160
Alimentazione	Benzina
Larghezza piastra	350/450 mm
Peso	148/157 kg



LG 504

967855505

COMPATTAZIONE LEGGERA
PIASTRA REVERSIBILE



Potenza	9,1 kW
Motore	Hatz 1D81Z
Avviamento	Elettrico
Alimentazione	Diesel
Larghezza piastra	700 mm
Peso operativo	499 kg

Optional:
indicatore di compattazione
kit piastre prolunga



LT 6005

967854504 (9")

967854505 (11")

COMPATTAZIONE LEGGERA
VIBROCOSTIPATORE VERTICALE

Potenza	2,7 kW
Motore	Honda GXR120
Alimentazione	Benzina
Larghezza piastra	230 / 280 mm
Peso operativo	68/69 kg
Indicatore intasamento filtro aria	
Conta ore	

Optional:
kit ruote di trasporto





LT 8005

967933901 (11")

967933902 (13")

COMPATTAZIONE LEGGERA
VIBROCOSTIPATORE VERTICALE

Potenza	3 kW
Motore	HATZ 1B20
Alimentazione	Diesel
Larghezza piastra	280 / 330 mm
Peso	98/99 kg
Indicatore intasamento filtro aria	

Optional:
kit ruote di trasporto



HUSQVARNA
SERVICE
CONTRACTS

BG 250

970614901

COMPATTAZIONE
LEGGERA

Potenza	5,5 kW
Alimentazione	Elettrica
Tensione	400 V
Corrente nominale, max	16 A
Velocità testa di levigatura, max	1.920 giri/min
Peso	146 kg



Per la selezione dell'utensile diamantato
vedere da pag. 79

BGS 250

IN ARRIVO - PRIMAVERA

COMPATTAZIONE
LEGGERA

Potenza	2,2 kW
Alimentazione	Elettrica
Tensione	230 V
Corrente nominale, max	16 A
Velocità testa di levigatura, max	1.440 giri/min
Peso	61 kg



Per la selezione dell'utensile diamantato
vedere da pag. 79

PG 280

970494601

TRATTAMENTO
DELLE PAVIMENTAZIONI

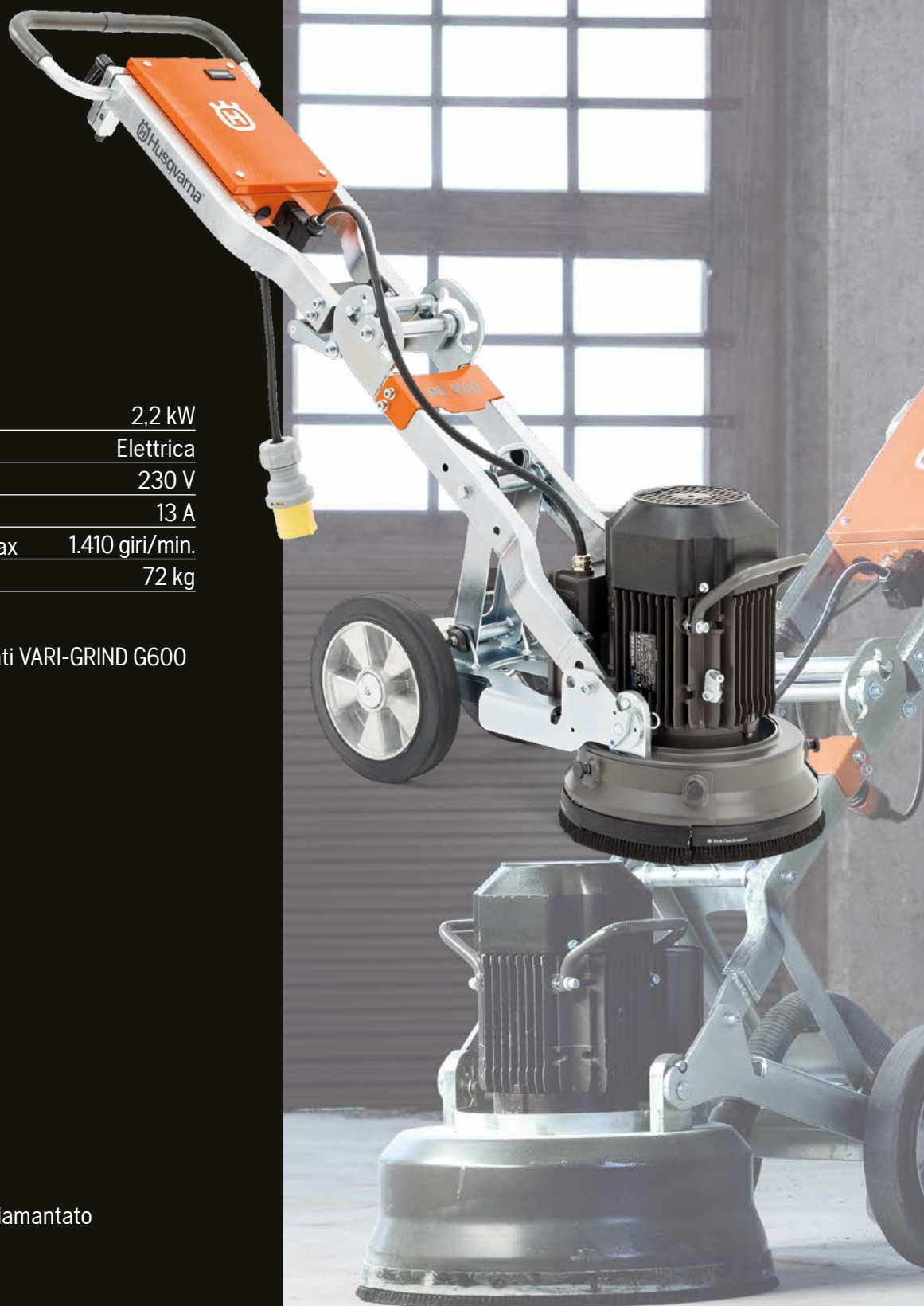

Potenza	2,2 kW
Alimentazione	Elettrica
Tensione	230 V
Corrente nominale, max	13 A
Velocità testa di levigatura, max	1.410 giri/min.
Peso	72 kg

n° 2 serie di utensili diamantati VARI-GRIND G600
utensile singolo

Optional:
aspiratore di polveri DE 120 H



Per la selezione dell'utensile diamantato
vedere da pag. 79



PG 450

967648601



TRATTAMENTO
DELLE PAVIMENTAZIONI

Potenza	2,2 kW
Alimentazione	Elettrica
Tensione	230 V
Corrente nominale, max	16 A
Velocità testa di levigatura, max	705 giri/min.
Peso	109 Kg

n° 1 serie di utensili diamantati VARI-GRIND G600
utensile singolo

Optional:
aspiratore di polveri DE 120 H o S 36 o T 4000



Per la selezione dell'utensile diamantato
vedere da pag. 79

HUSQVARNA
SERVICE
CONTRACTS

BMG 444 SC

970616604

TRATTAMENTO
DELLE PAVIMENTAZIONI

Potenza	2,2 kW
Tensione	230 V
Alimentazione	Elettrica
Corrente nominale, max	16 A
Velocità testa di levigatura, min	300 giri/min.
Velocità testa di levigatura, max	720 giri/min.
Peso	135 kg

Completo di kit di conversione ad utensili EZ
(9 adattatori e 9 piastrine EZ XX2)

Optional:
aspiratore di polveri S 36



Per la selezione dell'utensile diamantato
vedere da pag. 79

HUSQVARNA
SERVICE
CONTRACTS



BS 110

970615102

TRATTAMENTO DELLE PAVIMENTAZIONI

Potenza	1,5 kW
Tensione	230 V
Alimentazione	Elettrica
Corrente nominale, max	16 A
Larghezza operativa	da 5 cm (a seconda del tipo di lama)
Peso	170 kg

Completa di 4 lame assortite per usi diversi
(moquette, parquet, linoleum)

Optional:

aspiratore di polveri DE 120 H



Per la selezione dell'utensile diamantato
vedere da pag. 79

CG 200 G - Benzina

967662301

TRATTAMENTO DELLE PAVIMENTAZIONI

Potenza	4,1 kW
Motore	Honda
Alimentazione	Benzina
Larghezza operativa	200 mm
Profondità di asportazione	13 mm
Peso (escluso carburante, olio, utensili)	54 kg

completa di n. 1 tamburo con mole in tungsteno
(n. 84 mole + n. 84 distanziali)

Optional:
aspiratore di polveri DE 120 H



CG 200 E - Elettrica

967662401

TRATTAMENTO DELLE PAVIMENTAZIONI

Potenza	2,2 kW
Tensione	230 V
Alimentazione	Elettrica
Corrente nominale	max 16A
Larghezza operativa	200 mm
Profondità di asportazione	13 mm
Peso (escluso utensile)	58 kg

Optional:
aspiratore di polveri DE 120 H



BMP 215 - Petrol

Benzina

970616201

TRATTAMENTO DELLE PAVIMENTAZIONI

Potenza	4 kW
Alimentazione	Benzina
Velocità di rotazione	1.750 giri/min.
Larghezza operativa	215 mm
Peso	59 kg

Incluso tamburo completo di utensili pentagonali

Optional:
aspiratore di polveri S 36 o DE 120 H



BMP 215 - Elettrica

970616201

TRATTAMENTO DELLE PAVIMENTAZIONI

Potenza	1,8 kW
Tensione	230 V
Alimentazione	Elettrica
Corrente nominale, max	16 A
Velocità di rotazione	1.700 giri/min.
Larghezza operativa	215 mm
Peso	63 kg

Incluso tamburo completo di utensili pentagonali

Optional:
aspiratore di polveri S 36 o DE 120 H



BMP 265

970615601

TRATTAMENTO DELLE PAVIMENTAZIONI

Potenza	5,5 kW
Tensione	400 V
Alimentazione	Elettrica
Corrente nominale, max	max 16A
Velocità di rotazione	1.500 giri/ min
Larghezza operativa	265 mm
Peso	175 kg

Incluso tamburo completo di utensili ottagonali

Optional:
aspiratore di polveri S 36 o T 4000



**HUSQVARNA
SERVICE
CONTRACTS**



BG 245 E

967929301

COSTIPAMENTO DEL CALCESTRUZZO FRATTAZZATRICI

Potenza	1,5 kW
Tensione	230 V
Alimentazione	Elettrica
Diametro lama	600 mm
Sistema di sicurezza Quick-Stop	

Optional:

lame flottanti
disco flottante
kit ruote di trasporto



HUSQVARNA
SERVICE
CONTRACTS

A 1000

967672302



GESTIONE POLVERI E FANGHI DEPURATORI D'ARIA

Potenza	0,285 kW
Tensione	230 V
Alimentazione	elettrica monofase
Corrente nominale, max	1,2 A
Flusso d'aria	500/1000 m ³ /h
Filtro HEPA	3,5 m ²
Dimensioni	465x385x466 mm
Peso	20 kg



A 2000

967672202



GESTIONE POLVERI E FANGHI DEPURATORI D'ARIA

Potenza	0,75 kW
Tensione	230 V
Alimentazione	elettrica monofase
Corrente nominale, max	3,3 A
Flusso d'aria	1.000/2.000 m ³ /h
Filtro HEPA	10,5 m ²
Dimensioni	724x424x810 mm
Peso	38 kg





DE 110 H

970509401

GESTIONE POLVERI E FANGHI
ASPIRATORI PER POLVERI

Potenza	1,1 kW
Tensione	230 V
Alimentazione	elettrica monofase
Corrente nominale, max	5 A
Flusso d'aria	240 m ³ /h
Vuoto max	20 kPa
Classificato	H
Peso	25 kg
Tecnologia E-Flow	



**HUSQVARNA
SERVICE
CONTRACTS**

DE 110i H

970514902



GESTIONE POLVERI E FANGHI
ASPIRATORI PER POLVERI

Potenza	0,9 kW
Tensione	36 V
Alimentazione	batteria
Corrente nominale, max	5 A
Flusso d'aria, max	200 m ³ /h
Vuoto max	17 kPa
Peso	26 kg
Classificato	H
Tecnologia E-Flow	





DE 120 H

970514801

GESTIONE POLVERI E FANGHI ASPIRATORI PER POLVERI

Potenza	2,2 kW
Tensione	230 V
Alimentazione	elettrica monofase
Corrente nominale, max	10 A
Flusso d'aria, max	480 m ³ /h
Vuoto max	20 kPa
Peso	39 kg
Classificato	H
Tecnologia E-Flow	



W 70 P

967664704

GESTIONE POLVERI E FANGHI
ASPIRATORI PER FANGHI



Potenza	1,85 kW
Tensione	230 V
Alimentazione	elettrica monofase
Corrente nominale, max	8 A
Flusso d'aria max	200 m ³ /h
Vuoto max	22 kPa
Peso	44 kg

Attrezzatura consigliata per: tagliamuri e
tagliamuri a filo, motori da carotaggio,
mototroncatrici.



HUSQVARNA
SERVICE
CONTRACTS

SERIE SMART

VIBRAZIONE DEL
CALCESTRUZZO



Tensione	230 V
Diametro	40-48-56-65 mm
Raggio azione	diametro ago x 12
Lunghezza tubo	5 m
Lunghezza cavo elettrico	15 m



SERIE CF 11 VIBRASTAR

VIBRAZIONE DEL
CALCESTRUZZO



Tensione	230 V
Diametro	40-50-60 mm
Raggio azione	diametro ago x 8
Lunghezza tubo	5 m
Lunghezza cavo elettrico	10 m



SERIE AME 1600 CON SUPERFLEX ED AGO AT

VIBRAZIONE DEL
CALCESTRUZZO

Tensione	230 V
Diametro	39-49-59 mm
Raggio azione	diametro ago x 10
Lunghezza tubo	1-2-3-4 m
Lunghezza cavo elettrico	10 m



BV 30i

967973801

LAVORAZIONE DEL CALCESTRUZZO

Alimentazione	Batteria
Larghezza lavoro	1.800-4.200 cm
Peso (escluso batteria e caricabatteria)	11,5 kg

Optional:

batterie BLi 200 BLi 300
caricabatteria QC 330 o QC 500



BV 20 G

967856201

LAVORAZIONE DEL CALCESTRUZZO

Motore	Honda GX 25
Alimentazione	Benzina
Larghezza lavoro	200 cm
Vibrazioni	3,2 m/s ²
Capacità serbatoio carburante	0,58 l



WL 8i

970584901

LAMPADA

Alimentazione Batteria

Peso (escluso batteria e caricabatteria) 3,62 kg

Luce direzionale o a 360° grazie al diffusore

Optional:
diffusore
treppiede



WT 15i

599582409

SERBATOIO D'ACQUA

Capacità 15 l

Pressione dell'acqua max 0,9 bar

Lunghezza tubo integrato 3 m

Peso 3,6 kg

Compreso di batteria BLI 100
e caricabatteria QC 80



KNUT 39

IN ARRIVO - ESTATE

LEGATURA DELLE BARRE

Legatrice per barre altamente efficace e alimentata a batteria. Progettata per produrre nodi forti e costanti di altezza ridotta. Utilizza un filo d'acciaio di 1,5 mm

Fornito con valigetta di trasporto, 2 batterie 18 V e caricabatteria.



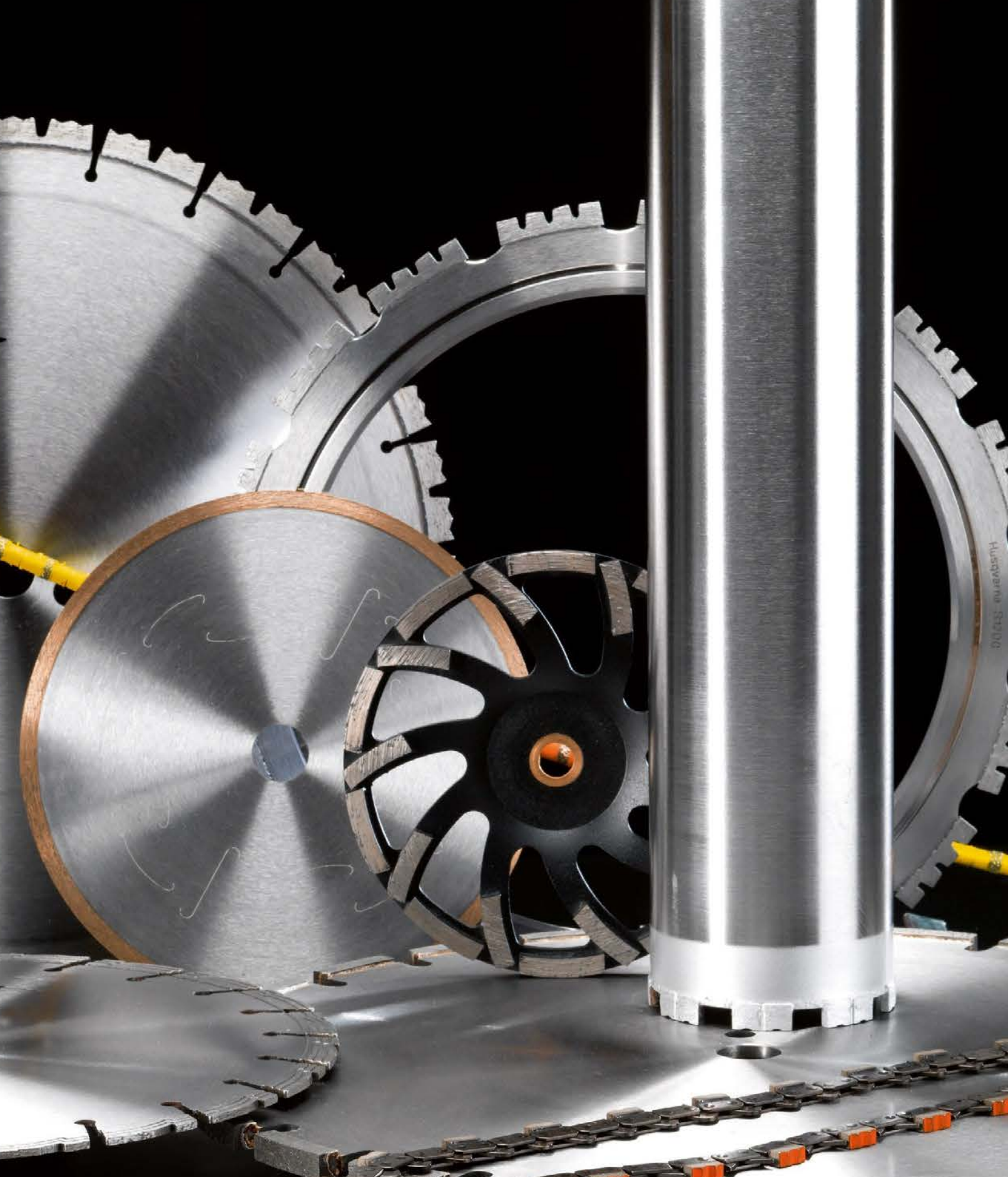

SOLUZIONI DIAMANTATE 2023

CONSTRUCTION PRODUCTS

PREZZI DI LISTINO

INFORMAZIONI SUL DISCO

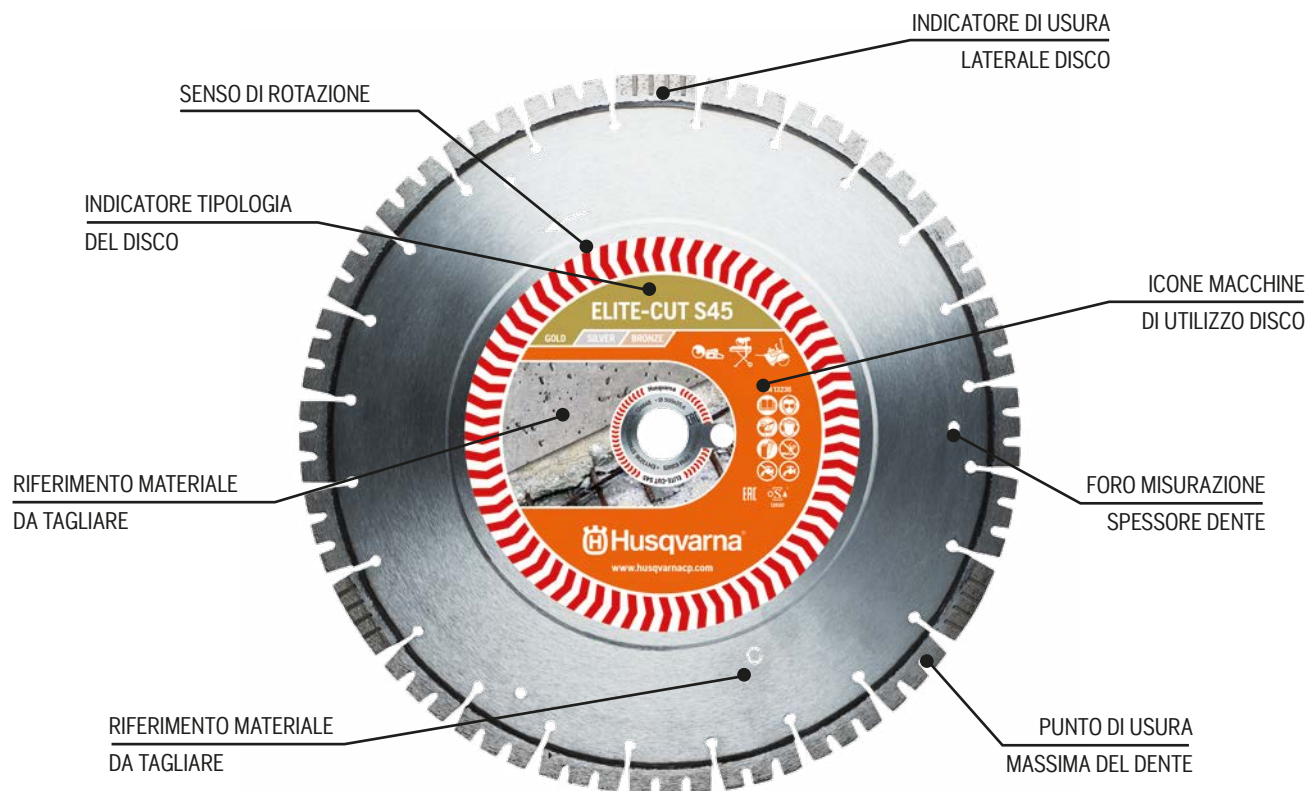

PIASTRELLE - GRES PORCELLANATO

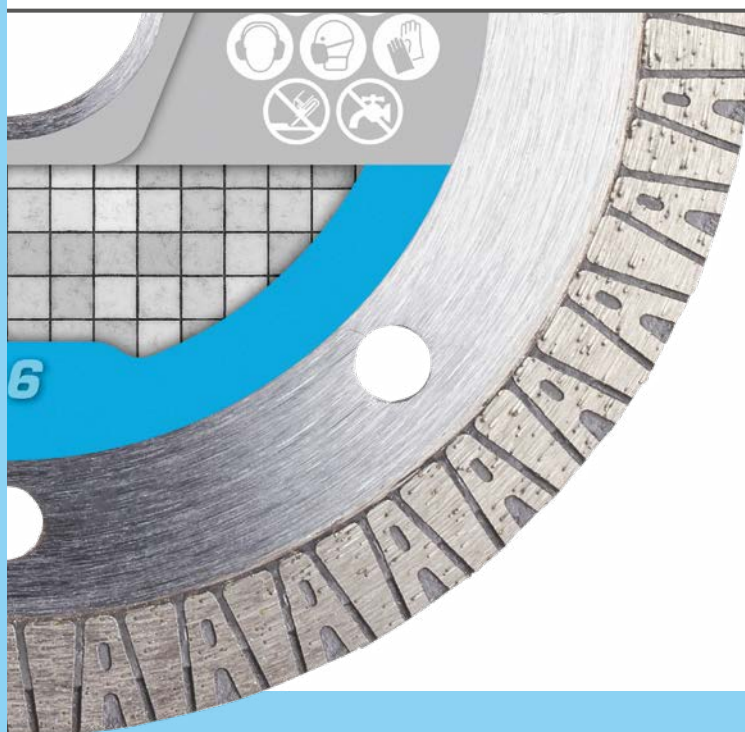

GOLD



ELITE-CUT S6

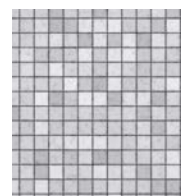

PIASTRELLE - GRES PORCELLANATO

CODICE	DIAMETRO MM	GEOMETRIA	FORMA SEGMENTO	ALTEZZA SEGMENTO MM	FORO MM	PREZZO LISTINO (IVA ESCLUSA)
579818830	115	CONTINUA	PIATTO	10	22,2	50,00 €
579818840	125	CONTINUA	PIATTO	10	22,2	56,00 €

GOLD



ELITE-CUT GS2S

ANIMA SILENZIATA

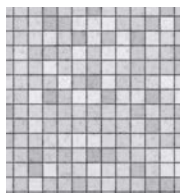

PIASTRELLE - GRES PORCELLANATO

CODICE	DIAMETRO MM	GEOMETRIA	FORMA SEGMENTO	ALTEZZA SEGMENTO MM	FORO MM	PREZZO LISTINO (IVA ESCLUSA)
579803460	180	CONTINUA	PIATTO	10	25,4	48,00 €
579803470	200	CONTINUA	PIATTO	10	25,4	58,00 €
579803480	230	CONTINUA	PIATTO	10	25,4	89,00 €
579803490	250	CONTINUA	PIATTO	10	25,4	125,00 €
579798110	300	CONTINUA	PIATTO	10	25,4	152,00 €
579798120	350	CONTINUA	PIATTO	10	25,4	177,00 €

SILVER



VARI-CUT S4

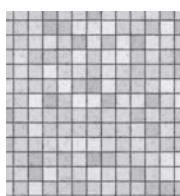

PIASTRELLE - GRES PORCELLANATO

CODICE	DIAMETRO MM	GEOMETRIA	FORMA SEGMENTO	ALTEZZA SEGMENTO MM	FORO MM	PREZZO LISTINO (IVA ESCLUSA)
579818930	115	CONTINUA	PIATTO	10	22,2	45,00 €

PIASTRELLE - GRES PORCELLANATO

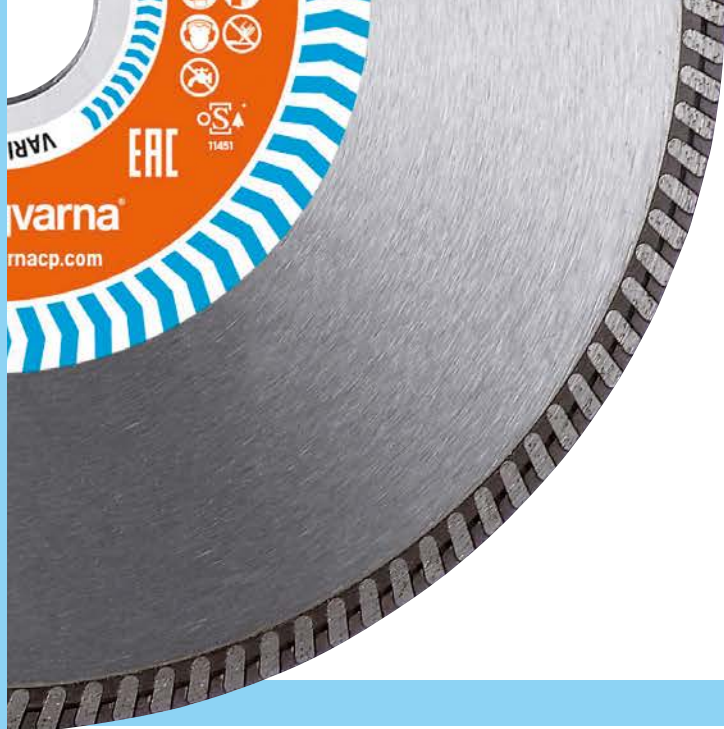

SILVER



VARI-CUT S6

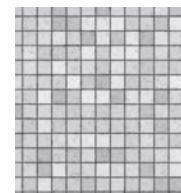

PIASTRELLE - GRES PORCELLANATO

CODICE	DIAMETRO MM	GEOMETRIA	FORMA SEGMENTO	ALTEZZA SEGMENTO MM	FORO MM	PREZZO LISTINO (IVA ESCLUSA)
582211130	115	CONTINUA	TURBO	10	22,2	45,00 €
582211180	230	CONTINUA	TURBO	10	22,2	107,00 €

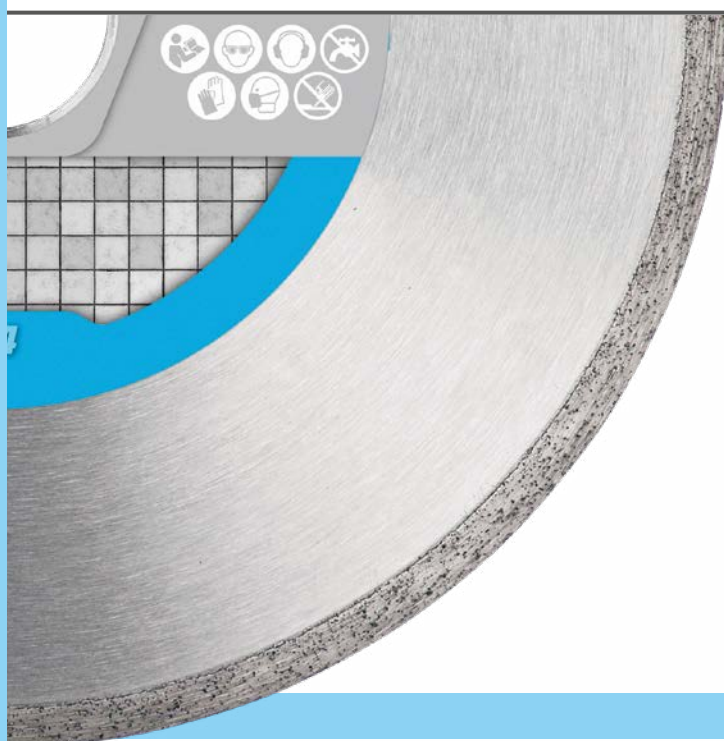

BRONZE



TACTI-CUT S4

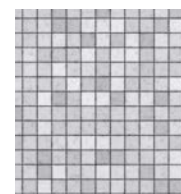

PIASTRELLE - GRES PORCELLANATO

CODICE	DIAMETRO MM	GEOMETRIA	FORMA SEGMENTO	ALTEZZA SEGMENTO MM	FORO MM	PREZZO LISTINO (IVA ESCLUSA)
579819630	115	CONTINUA	PIATTO	10	22,2	21,00 €
579819640	125	CONTINUA	PIATTO	10	22,2	27,00 €
579819680	230	CONTINUA	PIATTO	10	22,2	51,00 €

GOLD



ELITE-CUT S25

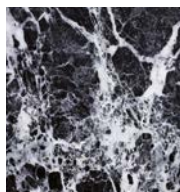

MARMO

CODICE	DIAMETRO MM	GOMETRIA	FORMA SEGMENTO	ALTEZZA SEGMENTO MM	FORO MM	PREZZO LISTINO (IVA ESCLUSA)
579804430	115	SEGMENTI RAVVICINATI	TURBO	12	22,2	87,00 €
579804440	125	SEGMENTI RAVVICINATI	TURBO	12	22,2	89,00 €
579804480	230	SEGMENTI RAVVICINATI	TURBO	12	22,2	173,00 €

SILVER



VARI-CUT S25

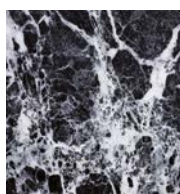

MARMO

CODICE	DIAMETRO MM	GOMETRIA	FORMA SEGMENTO	ALTEZZA SEGMENTO MM	FORO MM	PREZZO LISTINO (IVA ESCLUSA)
579807280	230	SEGMENTI RAVVICINATI	TURBO	10	22,2	107,00 €
535314010	300 NEW!	SEGMENTI RAVVICINATI	TURBO	12	25,4/20	126,00 €
535314020	350 NEW!	SEGMENTI RAVVICINATI	TURBO	12	25,4/20	198,00 €
535314030	400 NEW!	SEGMENTI RAVVICINATI	TURBO	12	25,4/20	255,00 €

MARMO

350 mm - Max 3.450 rpm - 63 m/s



SS PACE

ACE™
R HUSQVARNA K1PACE ONLY

GOLD



ELITE-CUT S35

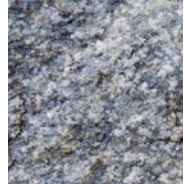

GRANITO

CODICE	DIAMETRO MM	GEOMETRIA	FORMA SEGMENTO	ALTEZZA SEGMENTO MM	FORO MM	PREZZO LISTINO (IVA ESCLUSA)
579804580	230	SEGMENTATA	PONTE	15	22,2	173,00 €
599494610	300	SEGMENTATA	EXO-GRIT Z-EDGE	15	20/25,4	247,00 €
599494620	350	SEGMENTATA	EXO-GRIT Z-EDGE	15	20/25,4	296,00 €
599494630	400	SEGMENTATA	EXO-GRIT Z-EDGE	15	20/25,4	428,00 €

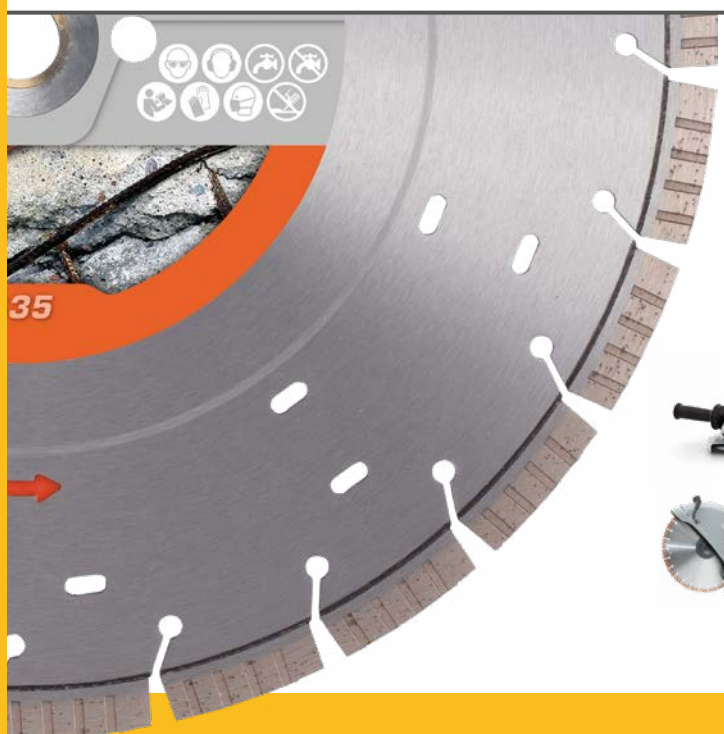

35

SILVER



VARI-CUT S35

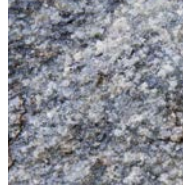

GRANITO

CODICE	DIAMETRO MM	GEOMETRIA	FORMA SEGMENTO	ALTEZZA SEGMENTO MM	FORO MM	PREZZO LISTINO (IVA ESCLUSA)
579807330	115	SEGMENTATA	TURBO	10	22,2	69,00 €
579807380	230	SEGMENTATA	TURBO	10	22,2	114,00 €
534972010	300 NEW!	SEGMENTATA	TURBO	12	25,4/20	207,00 €
534972020	350 NEW!	SEGMENTATA	TURBO	12	25,4/20	252,00 €
534972030	400 NEW!	SEGMENTATA	TURBO	12	25,4/20	310,00 €

GRANITO

BRONZE



TACTI-CUT S35



GRANITO

CODICE	DIAMETRO MM	GEOMETRIA	FORMA SEGMENTO	ALTEZZA SEGMENTO MM	FORO MM	PREZZO LISTINO (IVA ESCLUSA)
579820430	115	CONTINUA	TURBO	10	22,2	21,00 €
579820480	230	CONTINUA	TURBO	10	22,2	51,00 €
579815710	300	CONTINUA	TURBO	10	25,4/20	114,00 €
579815720	350	CONTINUA	TURBO	10	25,4/20	136,00 €

SILVER



VARI-CUT S35 TURBO



GRANITO

CODICE	DIAMETRO MM	GEOMETRIA	FORMA SEGMENTO	ALTEZZA SEGMENTO MM	FORO MM	PREZZO LISTINO (IVA ESCLUSA)
587905701	300	SEGMENTATA	TURBO	10	25,4/20	207,00 €
587905801	350	SEGMENTATA	TURBO	10	25,4/20	252,00 €
587905901	400	SEGMENTATA	TURBO	10	25,4/20	310,00 €

GRANITO

GOLD



ELITE-CUT S45



CEMENTO

CODICE	DIAMETRO MM	GEOMETRIA	FORMA SEGMENTO	ALTEZZA SEGMENTO MM	FORO MM	PREZZO LISTINO (IVA ESCLUSA)
579805080	230	SEGMENTATO	PONTE	15	22,2	173,00 €

SILVER



VARI-CUT S45



CEMENTO

CODICE	DIAMETRO MM	GEOMETRIA	FORMA SEGMENTO	ALTEZZA SEGMENTO MM	FORO MM	PREZZO LISTINO (IVA ESCLUSA)
579807580	230	SEGMENTATA	TURBO/PIATTO	10	22,2	91,00 €
534972110	300	SEGMENTATA	TURBO/PIATTO	12	25,4/20	207,00 €
534972120	350 NEW!	SEGMENTATA	TURBO/PIATTO	12	25,4/20	252,00 €
534972130	400 NEW!	SEGMENTATA	TURBO/PIATTO	12	25,4/20	310,00 €
534976950	450 NEW!	SEGMENTATA	TURBO/PIATTO	12	25,4	447,00 €
534976960	500 NEW!	SEGMENTATA	TURBO/PIATTO	12	25,4	517,00 €



GOLD



ELITE-CUT S45 EXO-GRIT™



CEMENTO

CODICE	DIAMETRO MM	GEOMETRIA	FORMA SEGMENTO	ALTEZZA SEGMENTO MM	FORO MM	PREZZO LISTINO (IVA ESCLUSA)
599494710	300	SEGMENTATA	Exo-Grit Z-Edge/Piatto	15	25,4/20	261,00 €
599494720	350	SEGMENTATA	Exo-Grit Z-Edge/Piatto	15	25,4/20	311,00 €
599494730	400	SEGMENTATA	Exo-Grit Z-Edge/Piatto	15	25,4/20	442,00 €
599494750	450	SEGMENTATA	Exo-Grit Z-Edge/Piatto	15	25,4	517,00 €
599494760	500	SEGMENTATA	Exo-Grit Z-Edge/Piatto	15	25,4	621,00 €
599494770	600	SEGMENTATA	Exo-Grit Z-Edge/Piatto	15	25,4	728,00 €



GOLD



ELITE-CUT S50



UNIVERSALE BLOCCHI/MATTONI

CODICE	DIAMETRO MM	GEOMETRIA	FORMA SEGMENTO	ALTEZZA SEGMENTO MM	FORO MM	PREZZO LISTINO (IVA ESCLUSA)
579804730	115	SEGMENTATA	PONTE	12	22,2	91,00 €
579804740	125	SEGMENTATA	PONTE	12	22,2	97,00 €
579804750	150	SEGMENTATA	PONTE	12	22,2	101,00 €
579804780	230	SEGMENTATA	PONTE	15	22,2	173,00 €



GOLD



ELITE-CUT GS50

ANIMA SILENZIATA



UNIVERSALE BLOCCHI/MATTONI

CODICE	DIAMETRO MM	GEOMETRIA	FORMA SEGMENTO	ALTEZZA SEGMENTO MM	FORO MM	PREZZO LISTINO (IVA ESCLUSA)
579804110	300	SEGMENTATA	PIATTO	12,0	25,4	184,00 €
579804120	350	SEGMENTATA	PIATTO	12,0	25,4	230,00 €
579804130	400	SEGMENTATA	PIATTO	12,0	25,4	375,00 €

SILVER



VARI-CUT S50



UNIVERSALE BLOCCHI/MATTONI

CODICE	DIAMETRO MM	GEOMETRIA	FORMA SEGMENTO	ALTEZZA SEGMENTO MM	FORO MM	PREZZO LISTINO (IVA ESCLUSA)
579807930	115	SEGMENTATA	TURBO/PIATTO	10	22,2	65,00 €
579807950	150	SEGMENTATA	TURBO/PIATTO	10	22,2	73,00 €
579807960	180	SEGMENTATA	TURBO/PIATTO	10	22,2	87,00 €
579807980	230	SEGMENTATA	TURBO/PIATTO	10	22,2	91,00 €
534972410	300 NEW!	SEGMENTATA	TURBO/PIATTO	12	25,4/20	207,00 €
534972420	350 NEW!	SEGMENTATA	TURBO/PIATTO	12	25,4/20	252,00 €
534972430	400 NEW!	SEGMENTATA	TURBO/PIATTO	12	25,4/20	310,00 €

BRONZE



TACTI-CUT S50-S50 PLUS



UNIVERSALE BLOCCHI/MATTONI

CODICE	DIAMETRO MM	GEOMETRIA	FORMA SEGMENTO	ALTEZZA SEGMENTO MM	FORO MM	PREZZO LISTINO (IVA ESCLUSA)
579819230	115	SEGMENTATA	PIATTO	10	22,2	21,00 €
579819280	230	SEGMENTATA	PIATTO	10	22,2	51,00 €
579815610	300	SEGMENTATA	PIATTO	13	25,4/20	114,00 €
579815620	350	SEGMENTATA	PIATTO	13	25,4/20	136,00 €
579815630	400	SEGMENTATA	PIATTO	13	25,4/20	173,00 €

UNIVERSALE BLOCCHI/MATTONI



GOLD



ELITE-CUT S65



CEMENTO/ASFALTO - MATERIALI ABRASIVI

CODICE	DIAMETRO MM	GEOMETRIA	FORMA SEGMENTO	ALTEZZA SEGMENTO MM	FORO MM	PREZZO LISTINO (IVA ESCLUSA)
579805180	230	SEGMENTATA	PONTE	15	22,2	198,00 €

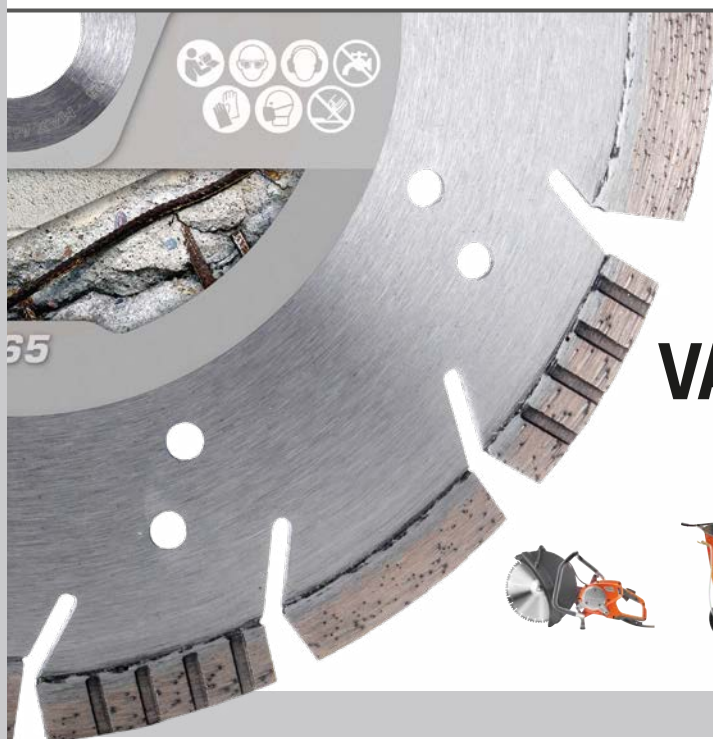

SILVER



VARI-CUT S65-S65 PLUS



CEMENTO/ASFALTO - MATERIALI ABRASIVI

CODICE	DIAMETRO MM	GEOMETRIA	FORMA SEGMENTO	ALTEZZA SEGMENTO MM	FORO MM	PREZZO LISTINO (IVA ESCLUSA)
579808080	230	SEGMENTATA	TURBO/PIATTO/PIATTO+	10	22,2	143,00 €
534972510	300 NEW!	SEGMENTATA	TURBO/PIATTO/PIATTO+	12	25,4/20	207,00 €
534972520	350 NEW!	SEGMENTATA	TURBO/PIATTO/PIATTO+	12	25,4/20	252,00 €
534972530	400 NEW!	SEGMENTATA	TURBO/PIATTO/PIATTO+	12	25,4/20	310,00 €
534977050	450 NEW!	SEGMENTATA	TURBO/PIATTO/PIATTO+	12	25,4	447,00 €
534977060	500 NEW!	SEGMENTATA	TURBO/PIATTO/PIATTO+	12	25,4	517,00 €

GOLD



ELITE-CUT S65 EXO GRIT™



CEMENTO/ASFALTO - MATERIALI ABRASIVI

CODICE	DIAMETRO MM	GOMETRIA	FORMA SEGMENTO	ALTEZZA SEGMENTO MM	FORO MM	PREZZO LISTINO (IVA ESCLUSA)
599494810	300	SEGMENTATA	Exo-Grit Z-Edge/Piatto/+	15	25,4/20	261,00 €
599494820	350	SEGMENTATA	Exo-Grit Z-Edge/Piatto/+	15	25,4/20	311,00 €
599494830	400	SEGMENTATA	Exo-Grit Z-Edge/Piatto/+	15	25,4/20	442,00 €
599494850	450	SEGMENTATA	Exo-Grit Z-Edge/Piatto/+	15	25,4/20	517,00 €
599494860	500	SEGMENTATA	Exo-Grit Z-Edge/Piatto/+	15	25,4/20	621,00 €
599494870	600	SEGMENTATA	Exo-Grit Z-Edge/Piatto/+	15	25,4/20	728,00 €

BRONZE



TACTI-CUT S65



CEMENTO/ASFALTO - MATERIALI ABRASIVI

CODICE	DIAMETRO MM	GOMETRIA	FORMA SEGMENTO	ALTEZZA SEGMENTO MM	FORO MM	PREZZO LISTINO (IVA ESCLUSA)
579820530	115	SEGMENTI RAVVICINATI	TURBO/PIATTO+	9	22,2	30,00 €
579820580	230	SEGMENTI RAVVICINATI	TURBO/PIATTO+	9	22,2	66,00 €
579816510	300	SEGMENTI RAVVICINATI	TURBO/PIATTO+	10	25,4/20	125,00 €
579816520	350	SEGMENTI RAVVICINATI	TURBO/PIATTO+	10	25,4/20	154,00 €
579816530	400	SEGMENTI RAVVICINATI	TURBO/PIATTO+	10	25,4/20	185,00 €

GOLD



ELITE-CUT S85



ASFALTO

CODICE	DIAMETRO MM	GEOMETRIA	FORMA SEGMENTO	ALTEZZA SEGMENTO MM	FORO MM	PREZZO LISTINO (IVA ESCLUSA)
579812010	300	SEGMENTATA	PIATTO/PIATTO +	12	25,4/20	261,00 €
579812020	350	SEGMENTATA	PIATTO/PIATTO +	12	25,4/20	311,00 €
579812030	400	SEGMENTATA	PIATTO/PIATTO +	12	25,4/20	442,00 €
579809550	450	SEGMENTATA	PIATTO/PIATTO +	12	25,4	517,00 €
579809560	500	SEGMENTATA	PIATTO/PIATTO +	12	25,4	615,00 €
579809570	600	SEGMENTATA	PIATTO/PIATTO +	12	25,4	731,00 €

SILVER



VARI-CUT S85



ASFALTO

CODICE	DIAMETRO MM	GEOMETRIA	FORMA SEGMENTO	ALTEZZA SEGMENTO MM	FORO MM	PREZZO LISTINO (IVA ESCLUSA)
579817710	300 NEW!	SEGMENTATA	PIATTO / PLUS	10	25,4/20	207,00 €
579817720	350 NEW!	SEGMENTATA	PIATTO / PLUS	10	25,4/20	252,00 €
579817730	400 NEW!	SEGMENTATA	PIATTO / PLUS	10	25,4/20	310,00 €
579809650	450 NEW!	SEGMENTATA	PIATTO +	10	25,4	447,00 €
579809660	500 NEW!	SEGMENTATA	PIATTO +	10	25,4	517,00 €

BRONZE



TACTI-CUT S85



ASFALTO

CODICE	DIAMETRO MM	GOMETRIA	FORMA SEGMENTO	ALTEZZA SEGMENTO MM	FORO MM	PREZZO LISTINO (IVA ESCLUSA)
579816610	300	SEGMENTATO	PIATTO+	10	25,4/20	125,00 €
579816620	350	SEGMENTATO	PIATTO+	10	25,4/20	154,00 €
579816630	400	SEGMENTATO	PIATTO+	10	25,4/20	184,00 €

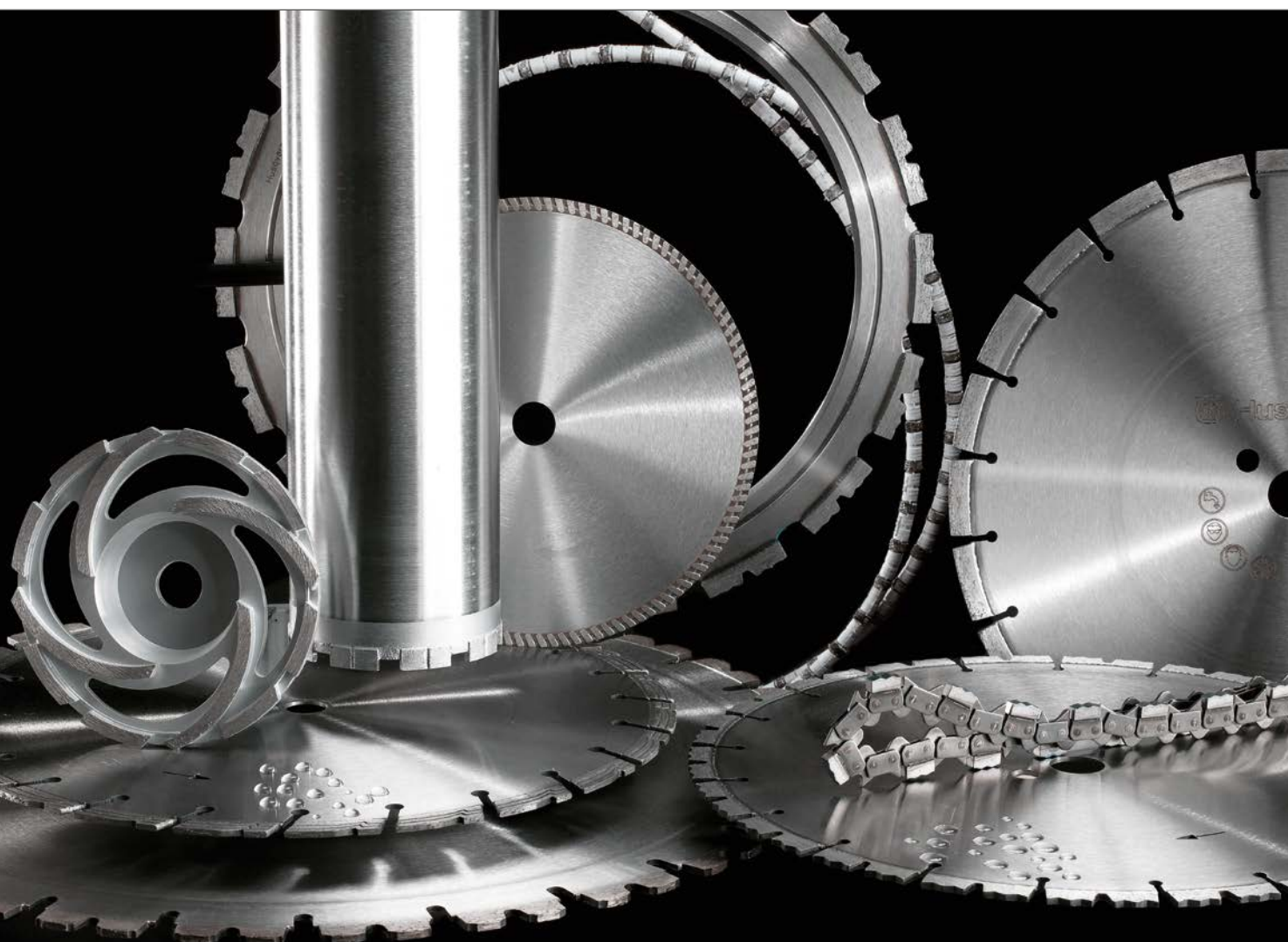

ASFALTO



GOLD



ELITE-RING



DISCHI DIAMANTATI PER MOTOTRONCATRICI AD ANELLO

NOME	CODICE	DIAMETRO MM	LUNGHEZZA SEGMENTO MM	LARGHEZZA SEGMENTO MM	ALTEZZA SEGMENTO MM	PREZZO LISTINO (IVA ESCLUSA)
ELITE-RING R10	583802301	370	33	4,2	9	598,00 €
ELITE-RING R10	593727701	425	33	4,2	13	767,00 €
ELITE-RING R20	587024201	370	33	4,2	9	598,00 €
ELITE-RING R20	593727901	425	33	4,2	13	767,00 €
ELITE-RING R45	587024301	370	33	4,2	9	598,00 €



SILVER



VARI-RING



DISCHI DIAMANTATI PER MOTOTRONCATRICI AD ANELLO

NOME	CODICE	DIAMETRO MM	LUNGHEZZA SEGMENTO MM	LARGHEZZA SEGMENTO MM	ALTEZZA SEGMENTO MM	PREZZO LISTINO (IVA ESCLUSA)
VARI-RING R20	574836301	370	33	4,2	9	424,00 €
VARI-RING R20	596807901	425	33	4,2	13	506,00 €
VARI-RING R45	574836302	370	33	4,2	9	424,00 €
VARI-RING R70	574836303	370	33	4,2	9	424,00 €
PRE-CUT RING BLADE	583802302	370	33	6,0	9	424,00 €
PRE-CUT RING BLADE	593727702	425	33	6,0	13	791,00 €
VARI-RING FR3	574478702	370	33	4,2	9	590,00 €
VARI-RING FR3	593727601	425	33	4,2	13	767,00 €

GOLD



ELITE-CUT



DISCHI DIAMANTATI PER MOTOTRONCATRICI CUT-N-BREAK

NOME	CODICE	DIAMETRO MM	LUNGHEZZA SEGMENTO MM	LARGHEZZA SEGMENTO MM	ALTEZZA SEGMENTO MM	NUMERO DISCHI
EL 10 CNB	597807901	230	40	2,4	8,5	528,00 €
EL 35 CNB	597808001	230	40	2,4	8,5	528,00 €
EL 70 CNB	597808301	230	40	2,4	8,5	528,00 €

DISCHI DIAMANTATI PER MOTOTRONCATRICI CUT-N-BREAK



GOLD



ELITE-CUT S35S BATTERY

SILENZIATO



UNIVERSALE BLOCCHI/MATTONI

CODICE	DIAMETRO MM	GEOMETRIA	FORMA SEGMENTO	ALTEZZA SEGMENTO MM	FORO MM	PREZZO LISTINO (IVA ESCLUSA)
596826601	230	SEGMENTI RAVVICINATI	TURBO	12	22,2	164,00 €
598715001	300	SEGMENTATA	EXO-GRIT Z-EDGE	15	25,4/20	su richiesta
529664001	350	SEGMENTATA	EXO-GRIT Z-EDGE	15	25,4/20	263,00 €

SILVER



VARI-CUT FR3 BATTERY

MULTI - MATERIALE



UNIVERSALE BLOCCHI/MATTONI

CODICE	DIAMETRO MM	GEOMETRIA	FORMA SEGMENTO	ALTEZZA SEGMENTO MM	FORO MM	PREZZO LISTINO (IVA ESCLUSA)
574853801	230	SEGMENTATA		2,8	22,2	124,00 €
574853901	300	SEGMENTATA		3,4	25,4	229,00 €
574854001	350	SEGMENTATA		3,4	25,4	263,00 €

BRONZE



TACTI-CUT S35S BATTERY

SILENZIATO



UNIVERSALE BLOCCHI/MATTONI

CODICE	DIAMETRO MM	GEOMETRIA	FORMA SEGMENTO	ALTEZZA SEGMENTO MM	FORO MM	PREZZO LISTINO (IVA ESCLUSA)
596520301	230	TURBO	CONTINUO	10	22,2	77,00 €
598714901	300	SEGMENTATA	SPESSORE RIDOTTO	10	25,4	su richiesta
529663901	350	SEGMENTATO	SPESSORE RIDOTTO	10	25,4	107,00 €

GOLD



ELITE-CUT

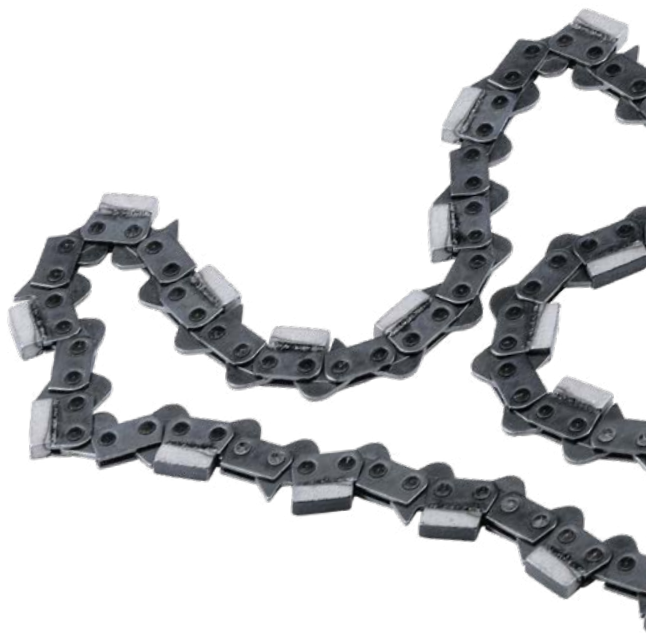

CATENE DIAMANTATE PER MOTOTRONCATRICI A CATENA

NOME	CODICE	PASSO CATENA POLLICI	LUNGHEZZA MM/POLLICI	NUMERO SEGMENTI	LARGHEZZA SEGMENTO MM	PREZZO LISTINO (IVA ESCLUSA)
ELITE C 20	593064301	0,444	450/18	30	5,7	1.760,00 €
ELITE C 45	590765401	0,444	450/18	30	5,7	1.760,00 €

SILVER



VARI-CUT

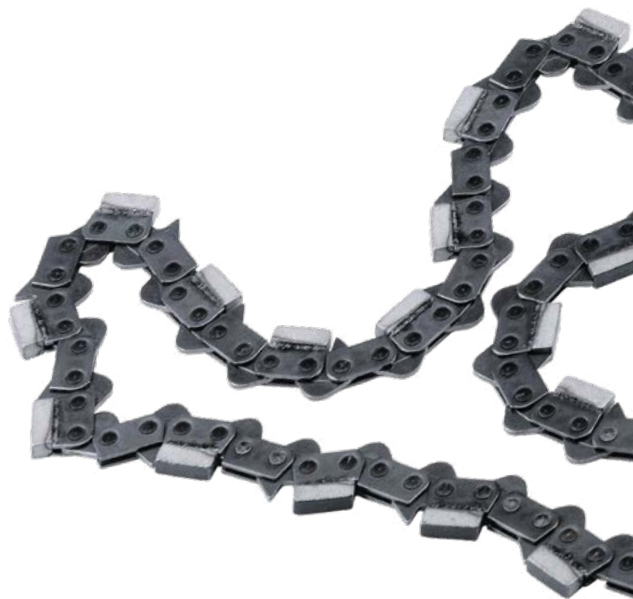

CATENE DIAMANTATE PER MOTOTRONCATRICI A CATENA

NOME	CODICE	PASSO CATENA POLLICI	LUNGHEZZA MM/POLLICI	NUMERO SEGMENTI	LARGHEZZA SEGMENTO MM	PREZZO LISTINO (IVA ESCLUSA)
VARI C45	590765501	0,444	450/18	30	5,7	1.185,00 €

CATENE DIAMANTATE PER MOTOTRONCATRICI A CATENA

SILVER



VARI-GRIND G35



MOLE DIAMANTATE

CODICE	DIAMETRO MM	ALTEZZA SEGMENTO MM	ATTACCO	GEOMETRIA	PREZZO LISTINO (IVA ESCLUSA)
579821130	115	5	22,2/M 14	FAN	89,00 €
579821140	125	5	22,2/M 14	FAN	108,00 €
579821150	150	5	19,0	FAN	188,00 €
579821160	180	5	22,2/M 14	FAN	223,00 €

MOLE DIAMANTATE



SILVER



VARI-GRIND G50

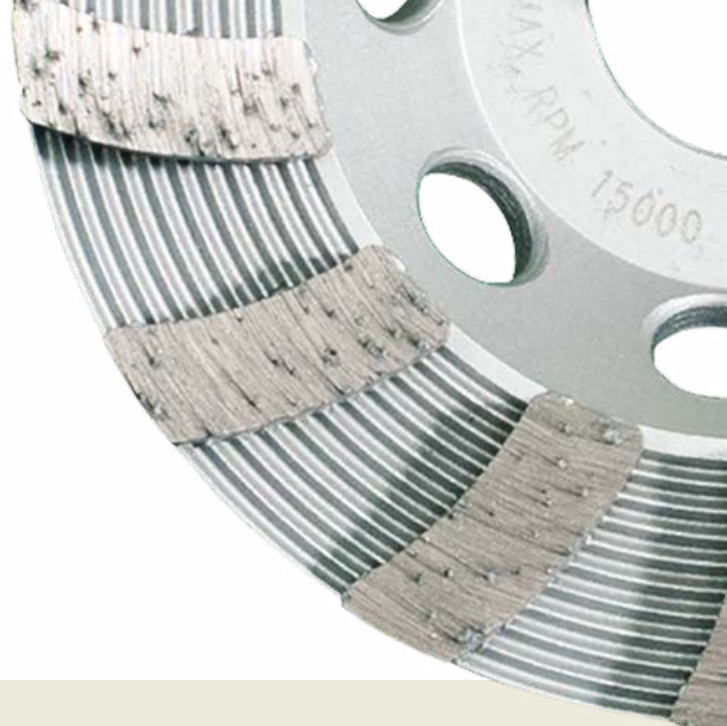

MOLE DIAMANTATE

CODICE	DIAMETRO MM	ALTEZZA SEGMENTO MM	ATTACCO	GEOMETRIA	PREZZO LISTINO (IVA ESCLUSA)
579821430	115	5	22,2/M 14	TURBO	108,00 €
579821440	125	5	22,2/M 14	TURBO	115,00 €
579821460	180	5	22,2/M 14	TURBO	250,00 €

SILVER



VARI-GRIND G65

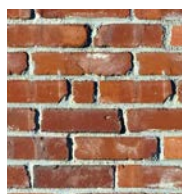

MOLE DIAMANTATE

CODICE	DIAMETRO MM	ALTEZZA SEGMENTO MM	ATTACCO	GEOMETRIA	PREZZO LISTINO (IVA ESCLUSA)
579821530	115	5	22,2/M 14	DOPPIA FILA	108,00 €
579821540	125	5	22,2/M 14	DOPPIA FILA	111,00 €
579821560	180	5	22,2/M 14	DOPPIA FILA	319,00 €

MOLE DIAMANTATE



BRONZE



TACTI-GRIND G45



MOLE DIAMANTATE

CODICE	DIAMETRO MM	ALTEZZA SEGMENTO MM	ATTACCO	GEOMETRIA	PREZZO LISTINO (IVA ESCLUSA)
582238940	125	5	22,2/M 14	MONOFILA	70,00 €



BRONZE



TACTI-GRIND G50



MOLE DIAMANTATE

CODICE	DIAMETRO MM	ALTEZZA SEGMENTO MM	ATTACCO	GEOMETRIA	PREZZO LISTINO (IVA ESCLUSA)
582242230	115	5	22,2/M 14	TURBO	80,00 €
582242240	125	5	22,2/M 14	TURBO	87,00 €
582242260	180	5	22,2/M 14	TURBO	188,00 €

BRONZE



TACTI-GRIND G65

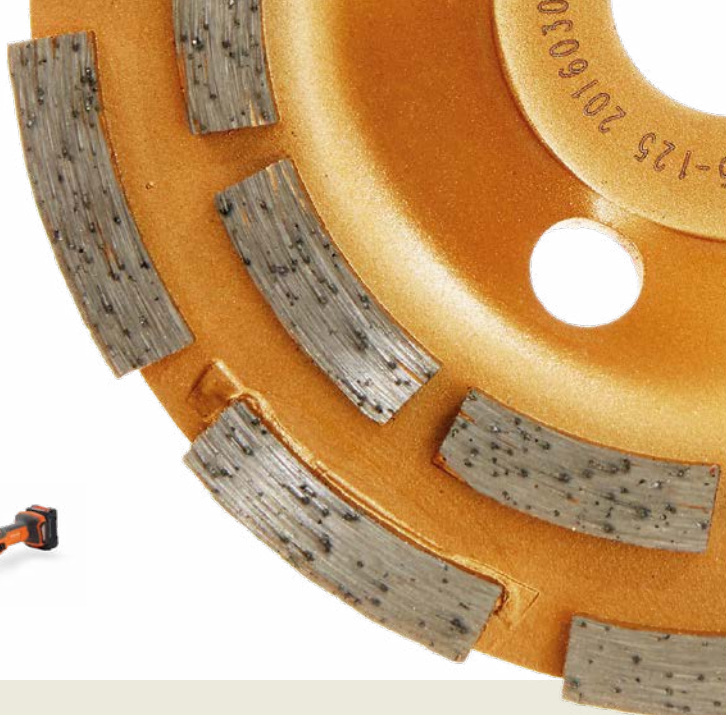

MOLE DIAMANTATE

CODICE	DIAMETRO MM	ALTEZZA SEGMENTO MM	ATTACCO	GEOMETRIA	PREZZO LISTINO (IVA ESCLUSA)
582242330	115	5	22,2/M 14	DOPPIA FILA	79,00 €
582242340	125	5	22,2/M 14	DOPPIA FILA	80,00 €
582242360	180	5	22,2/M 14	DOPPIA FILA	235,00 €



MOLE DIAMANTATE

GOLD



ELITE-DRILL D1510 Z



FORETTI

CODICE	DIAMETRO MM	ATTACCO	LUNGHEZZA MM	SEGMENTO DIMENSIONI MM	NUMERO SEGMENTI	PREZZO LISTINO (IVA ESCLUSA)
529559202	82	1 1/4"	500	24×4.0×8.0+2	8	277,00 €
529555502	92	1 1/4"	500	24×4.0×8.0+2	9	281,00 €
529555602	102	1 1/4"	500	24×4.0×8.0+2	9	289,00 €
529555702	107	1 1/4"	500	24×4.0×8.0+2	10	328,00 €
529555802	112	1 1/4"	500	24×4.0×8.0+2	10	335,00 €
529555902	122	1 1/4"	500	24×4.0×8.0+2	11	364,00 €
529556002	127	1 1/4"	500	24×4.0×8.0+2	12	394,00 €
529556102	132	1 1/4"	500	24×4.0×8.0+2	12	406,00 €
529556202	142	1 1/4"	500	24×4.0×8.0+2	12	419,00 €
529556302	152	1 1/4"	500	24×4.0×8.0+2	13	447,00 €
529556402	162	1 1/4"	500	24×4.0×8.0+2	13	465,00 €
529556502	172	1 1/4"	500	24×4.0×8.0+2	14	497,00 €
529556602	182	1 1/4"	500	24×4.0×8.0+2	14	525,00 €
529556702	200	1 1/4"	500	24×4.0×8.0+2	15	607,00 €
529556802	225	1 1/4"	500	24×4.0×8.0+2	15	784,00 €
529556902	250	1 1/4"	500	24×4.0×8.0+2	17	805,00 €
529557002	300	1 1/4"	500	24×4.0×8.0+2	19	895,00 €
529557102	350	1 1/4"	500	24×4.0×8.0+2	22	965,00 €

GOLD



ELITE-DRILL D1420



FORETTI

CODICE	DIAMETRO MM	ATTACCO	LUNGHEZZA MM	SEGMENTO DIMENSIONI MM	NUMERO SEGMENTI	PREZZO LISTINO (IVA ESCLUSA)
586424604	16	1 1/4"	500	3,2x7,5+2	CORONA	147,00 €
586425215	18	1 1/4"	500	3,2x7,5+2	CORONA	147,00 €
586425314	20	1 1/4"	500	3,2x7,5+2	CORONA	147,00 €
586425711	22	1 1/4"	500	3,2x7,5+2	CORONA	152,00 €
586425911	24	1 1/4"	500	3,2x7,5+2	CORONA	152,00 €
586426008	25	1 1/4"	500	3,2x7,5+2	CORONA	152,00 €
586426206	26	1 1/4"	500	3,2x7,5+2	CORONA	161,00 €
586426311	28	1 1/4"	500	3,2x7,5+2	CORONA	161,00 €
586426604	29	1 1/4"	500	3,2x7,5+2	CORONA	161,00 €
586426905	32	1 1/4"	500	3,2x7,5+2	CORONA	168,00 €
586427511	35	1 1/4"	500	3,2x7,5+2	CORONA	175,00 €
586427704	38	1 1/4"	500	3,2x7,5+2	CORONA	175,00 €
587864805	40	1 1/4"	500	3,2x7,5+2	CORONA	175,00 €
586428405	45	1 1/4"	500	3,2x7,5+2	CORONA	184,00 €
586083502	52	1 1/4"	500	24x3,5x9+2	5	184,00 €
586083702	62	1 1/4"	500	24x3,5x9+2	6	213,00 €
586084102	72	1 1/4"	500	24x3,5x9+2	6	253,00 €
586084502	82	1 1/4"	500	24x4x9+2	7	277,00 €
586084802	92	1 1/4"	500	24x4x9+2	8	281,00 €
586085002	102	1 1/4"	500	24x4x9+2	8	289,00 €
586085102	107	1 1/4"	500	24x4x9+2	9	335,00 €
586085202	112	1 1/4"	500	24x4x9+2	9	328,00 €
586085502	122	1 1/4"	500	24x4x9+2	10	364,00 €
586085702	127	1 1/4"	500	24x4x9+2	10	394,00 €
586085902	132	1 1/4"	500	24x4x9+2	11	406,00 €
586086102	142	1 1/4"	500	24x4x9+2	11	419,00 €
586086302	152	1 1/4"	500	24x4,5x9+2	12	447,00 €
586086402	162	1 1/4"	500	24x4,5x9+2	12	465,00 €
586086702	172	1 1/4"	500	24x4,5x9+2	13	497,00 €
586087002	182	1 1/4"	500	24x4,5x9+2	13	525,00 €
586087502	200	1 1/4"	500	24x4,5x9+2	14	607,00 €
586088102	225	1 1/4"	500	24x4,5x9+2	15	784,00 €
586088402	250	1 1/4"	500	24x4,5x9+2	16	805,00 €
586088802	275	1 1/4"	500	24x4,5x9+2	18	861,00 €
586089002	300	1 1/4"	500	24x4,5x9+2	18	895,00 €
586089502	350	1 1/4"	500	24x4,5x9+2	21	965,00 €
586089902	400	1 1/4"	500	24x5x9+2	24	1.013,00 €
586090102	450	1 1/4"	500	24x5x9+2	26	1.067,00 €
586090202	500	1 1/4"	500	24x5x9+2	30	1.406,00 €
586090602	600	1 1/4"	500	24x5x9+2	32	1.665,00 €

FORETTI

SILVER



VARI-DRILL D25



FORETTI

CODICE	DIAMETRO MM	ATTACCO	LUNGHEZZA MM	SEGMENTO DIMENSIONI MM	NUMERO SEGMENTI	PREZZO LISTINO (IVA ESCLUSA)
586099601	37	M16	150	16,0x3,0x9,0	4	99,00 €
586099701	52	M16	150	24,0x3,5x9,0	4	113,00 €
586099801	57	M16	150	24,0x3,5x9,0	4	118,00 €
586099901	68	M16	150	24,0x3,5x9,0	4	162,00 €
586100001	85	M16	150	24,0x3,5x9,0	4	184,00 €
586100101	107	M16	150	24,0x4,0x9,0	5	217,00 €
586100201	117	M16	150	24,0x4,0x9,0	5	222,00 €
586100301	127	M16	150	24,0x4,0x9,0	6	255,00 €
586100401	152	M16	150	24,0x4,0x9,0	7	269,00 €
586100501	162	M16	150	24,0x4,0x9,0	8	284,00 €

ACCESSORI D25

CODICE	TIPO	PREZZO LISTINO (IVA ESCLUSA)
586171901	Punta per adattatore, conica 8 mm, HEX - M 16 M	26,00 €
586172001	Punta per adattatore, conica 8 mm, SDS - M 16 M	37,00 €
586172101	Punta per adattatore, conica 8 mm, 1 / 2" G M - M 16 M	30,00 €
586172201	PUNTA DI CENTRAGGIO PER RACCORDO - CONICA	13,00 €
586172501	PROLUNGA PER CORONE, 250 MM, M 16 F - M 16 M	30,00 €

KIT VALIGETTA

CODICE	DIAMETRI MM	PREZZO LISTINO (IVA ESCLUSA)
586100701	52 - 57 - 68 - 85 - 107	639,00 €
	Punta per adattatore, punta di centraggio, prolunga per corone	



SILVER



VARI-DRILL D05

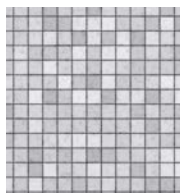

FORETTI

CODICE	DIAMETRO MM	ATTACCO	LUNGHEZZA MM	SEGMENTO DIMENSIONI MM	PREZZO LISTINO (IVA ESCLUSA)
522970501	6	HEX	25	1,5x1,5	42,00 €
522970701	8	HEX	25	1,5x1,5	44,00 €
522970801	10	HEX	25	1,5x1,5	48,00 €
522970901	12	HEX	25	1,5x1,5	53,00 €
522971101	20	M14	35	2,0x2,5	79,00 €
522971201	27	M14	35	2,0x2,5	103,00 €
522971301	35	M14	35	2,0x2,5	118,00 €
522971401	45	M14	35	2,0x2,5	132,00 €
522971501	50	M14	35	2,0x2,5	136,00 €
522971601	55	M14	35	2,0x2,5	147,00 €
522971701	60	M14	35	2,0x2,5	156,00 €
522971801	65	M14	35	2,0x2,5	173,00 €

ACCESSORI D05

CODICE	TIPO	PREZZO LISTINO (IVA ESCLUSA)
575317301	PUNTA PER ADATTATORE M 14-HEX	26,00 €
522975101	SISTEMA DI CENTRAGGIO PER DIAMETRI 5-12 MM	26,00 €
522975201	SISTEMA DI CENTRAGGIO PER DIAMETRI 20-65 MM	44,00 €

SILVER



VARI-DRILL D35



FORETTI

CODICE	DIAMETRO MM	ATTACCO	LUNGHEZZA MM	SEGMENTO DIMENSIONI MM	NUMERO SEGMENTI	PREZZO LISTINO (IVA ESCLUSA)
522790401	37	1 1/4"	350	16,3x3,0x6,5	4	167,00 €
522790501	47	1 1/4"	350	24,0x3,5x6,5	4	189,00 €
522790601	57	1 1/4"	350	24,0x3,5x6,5	4	194,00 €
522790701	72	1 1/4"	350	24,0x3,5x6,5	5	200,00 €
522790801	87	1 1/4"	350	24,0x3,5x6,5	6	221,00 €
522790901	112	1 1/4"	350	24,0x4,0x6,5	8	273,00 €
522791001	127	1 1/4"	350	24,0x4,0x6,5	9	341,00 €
522791101	152	1 1/4"	350	24,0x4,0x6,5	12	401,00 €
522791201	162	1 1/4"	350	24,0x4,0x6,5	12	431,00 €
522791301	200	1 1/4"	350	24,0x4,0x6,5	14	562,00 €

ACCESSORI D35

CODICE	TIPO	PREZZO LISTINO (IVA ESCLUSA)
581799401	DISPOSITIVO DI CENTRAGGIO ø 37 MM	73,00 €
581799402	DISPOSITIVO DI CENTRAGGIO ø 47 MM	90,00 €
581799403	DISPOSITIVO DI CENTRAGGIO ø 57 MM	90,00 €
581799404	DISPOSITIVO DI CENTRAGGIO ø 72 MM	67,00 €
581799405	DISPOSITIVO DI CENTRAGGIO ø 87 MM	67,00 €
581799406	DISPOSITIVO DI CENTRAGGIO ø 112 MM	90,00 €
581799407	DISPOSITIVO DI CENTRAGGIO ø 127 MM	77,00 €
581799408	DISPOSITIVO DI CENTRAGGIO ø 152 MM	90,00 €
581799409	DISPOSITIVO DI CENTRAGGIO ø 162 MM	90,00 €
543095432	DISPOSITIVO DI CENTRAGGIO ø 200 MM	114,00 €
543077061	ADATTATORE DI ASPIRAZIONE, 1/2" G M - 1 1/4" M	267,00 €
543080832	PROLUNGHE ALLUMINIO 300 MM 1 1/4	77,00 €

BRONZE



TACTI-DRILL D20



FORETTI

CODICE	DIAMETRO MM	ATTACCO	LUNGHEZZA MM	SEGMENTO DIMENSIONI MM	PREZZO LISTINO (IVA ESCLUSA)
582076901	52	1 1/4"	500	24,0x3,5x7,0+2	123,00 €
582077101	62	1 1/4"	500	24,0x3,5x7,0+2	151,00 €
582077301	72	1 1/4"	500	24,0x3,5x7,0+2	164,00 €
582077401	82	1 1/4"	500	24,0x3,5x7,0+2	184,00 €
582077601	102	1 1/4"	500	24,0x3,5x7,0+2	211,00 €
582078001	112	1 1/4"	500	24,0x3,5x7,0+2	261,00 €
582078101	122	1 1/4"	500	24,0x3,7x7,0+2	275,00 €
582078201	132	1 1/4"	500	24,0x3,7x7,0+2	294,00 €
582078301	152	1 1/4"	500	24,0x3,7x7,0+2	330,00 €
582078401	162	1 1/4"	500	24,0x4,0x7,0+2	348,00 €
582078501	182	1 1/4"	500	24,0x4,0x7,0+2	385,00 €
582078601	200	1 1/4"	500	24,0x4,0x7,0+2	440,00 €
582078701	225	1 1/4"	500	24,0x4,0x7,0+2	528,00 €
582078801	250	1 1/4"	500	24,0x4,3x7,0+2	582,00 €
582078901	300	1 1/4"	500	24,0x4,3x7,0+2	816,00 €

GOLD



ELITE DRILL D 10 TW BATTERY



FORETTI

CODICE	DIAMETRO MM	ATTACCO	LUNGHEZZA MM	SEGMENTO DIMENSIONI MM	NUMERO SEGMENTI	PREZZO LISTINO (IVA ESCLUSA)
535686901	10	½"	200	2.3×7.5	CORONA	174,00 €
535691701	12	½"	200	2.3×7.5	CORONA	174,00 €
535691801	14	½"	200	2.3×7.5	CORONA	174,00 €
535691901	16	½"	350	2.3×7.5	CORONA	174,00 €
535692001	18	½"	350	2.3×7.5	CORONA	175,00 €
535692101	20	½"	350	2.3×7.5	CORONA	175,00 €
535692201	22	½"	350	2.3×7.5	CORONA	177,00 €
535692401	25	½"	350	2.3×7.5	CORONA	179,00 €
535692501	28	½"	350	2.3×7.5	CORONA	179,00 €
535692601	30	½"	350	2.3×7.5	CORONA	181,00 €
535692701	32	½"	350	2.3×7.5	CORONA	181,00 €
535692801	35	½"	350	2.3×7.5	CORONA	206,00 €
535692901	40	½"	350	2.3×7.5	CORONA	206,00 €
535693201	45	½"	350	2.3×7.5	CORONA	206,00 €
536079001	51	½"	350	20×2.5×8.0+2	5	270,00 €
535693401	61	½"	350	20×2.5×8.0+2	6	277,00 €
535693601	71	½"	350	20×2.5×8.0+2	7	328,00 €
535693801	81	½"	350	20×2.5×8.0+2	8	359,00 €
535693901	91	½"	350	20×2.5×8.0+2	9	369,00 €
535694001	101	½"	350	20×2.5×8.0+2	10	380,00 €

GOLD



PIRANHA™ G11



PLACCHETTE DIAMANTATE PER LEVIGATRICI

CODICE	DENOMINAZIONE	DESCRIZIONE	ROTAZIONE	PREZZO LISTINO (IVA ESCLUSA)
543327301	G11X1S	PIASTRA PCD SINGOLA	IN SENSO ANTIORARIO	384,00 €
543327302	G11X1D	PIASTRA PCD DOPPIA	IN SENSO ANTIORARIO	644,00 €

GOLD



SHARX™



PLACCHETTE DIAMANTATE PER LEGAVITRICI

CODICE	DENOMINAZIONE	DESCRIZIONE	ROTAZIONE	PREZZO LISTINO (IVA ESCLUSA)
574430402	SHARX™	SINGOLO		304,00 €
574430403	SHARX™	DOPPIO		470,00 €



GOLD



ELITE-GRIND G1400



PLACCHETTE DIAMANTATE PER LEVIGATRICI

CODICE	DENOMINAZIONE	COLORE	SINGOLO/ DOPPIO	ALTEZZA SEGMENTO MM	GRANA	DUREZZA LEGANTE	PREZZO LISTINO (IVA ESCLUSA)
G 1410 (Confezione 3 pezzi)							
501897901	G 1413 S	ARANCIONE	SINGOLO	13	20	X-MORBIDO	327,00 €
501897902	G 1413 D	ARANCIONE	DOPPIO	13	20	X-MORBIDO	504,00 €
501898901	G 1414 S	ARANCIONE	SINGOLO	13	30	X-MORBIDO	327,00 €
501898902	G 1414 D	ARANCIONE	DOPPIO	13	30	X-MORBIDO	504,00 €
501899201	G 1415 S	ARANCIONE	SINGOLO	13	50	X-MORBIDO	327,00 €
501899202	G 1415 D	ARANCIONE	DOPPIO	13	50	X-MORBIDO	504,00 €
501899701	G 1416 S	ARANCIONE	SINGOLO	13	100	X-MORBIDO	327,00 €
501899702	G 1416 D	ARANCIONE	DOPPIO	13	100	X-MORBIDO	504,00 €
G 1420 (Confezione 3 pezzi)							
501899901	G 1423 S	GIALLO	SINGOLO	13	20	MORBIDO	327,00 €
501899902	G 1423 D	GIALLO	DOPPIO	13	20	MORBIDO	504,00 €
501900701	G 1424 S	GIALLO	SINGOLO	13	30	MORBIDO	327,00 €
501900702	G 1424 D	GIALLO	DOPPIO	13	30	MORBIDO	504,00 €
501900801	G 1425 S	GIALLO	SINGOLO	13	50	MORBIDO	327,00 €
501900802	G 1425 D	GIALLO	DOPPIO	13	50	MORBIDO	504,00 €
501901501	G 1426 S	GIALLO	SINGOLO	13	100	MORBIDO	327,00 €
501901502	G 1426 D	GIALLO	DOPPIO	13	100	MORBIDO	504,00 €
G 1440 (Confezione 3 pezzi)							
501902501	G 1443 S	ROSA	SINGOLO	13	20	MEDIO	327,00 €
501902502	G 1443 D	ROSA	DOPPIO	13	20	MEDIO	504,00 €
501904901	G 1444 S	ROSA	SINGOLO	13	30	MEDIO	327,00 €
501904902	G 1444 D	ROSA	DOPPIO	13	30	MEDIO	504,00 €
501906501	G 1445 S	ROSA	SINGOLO	13	50	MEDIO	327,00 €
501906502	G 1445 D	ROSA	DOPPIO	13	50	MEDIO	504,00 €
501907401	G 1446 S	ROSA	SINGOLO	13	100	MEDIO	327,00 €
501907402	G 1446 D	ROSA	DOPPIO	13	100	MEDIO	504,00 €
G 1470 (Confezione 3 pezzi)							
501907701	G 1473 S	ROSSO	SINGOLO	13	20	DURO	327,00 €
501907702	G 1473 D	ROSSO	DOPPIO	13	20	DURO	504,00 €
501907901	G 1474 S	ROSSO	SINGOLO	13	30	DURO	327,00 €
501907902	G 1474 D	ROSSO	DOPPIO	13	30	DURO	504,00 €
501908101	G 1475 S	ROSSO	SINGOLO	13	50	DURO	327,00 €
501908102	G 1475 D	ROSSO	DOPPIO	13	50	DURO	504,00 €
G 1480 (Confezione 3 pezzi)							
501908201	G 1483 D	BLU	DOPPIO	13	20	X-DURO	327,00 €
501908202	G 1483 T	BLU	TRIPLO	13	20	X-DURO	504,00 €
501908301	G 1484 D	BLU	DOPPIO	13	20	X-DURO	327,00 €
501908302	G 1484 T	BLU	TRIPLO	13	20	X-DURO	504,00 €

SILVER



VARI-GRIND G600



PLACCHETTE DIAMANTATE PER LEVIGATRICI

CODICE	DENOMINAZIONE	COLORE	SINGOLO/ DOPPIO	ALTEZZA SEGMENTO MM	GRANA	DUREZZA LEGANTE	PREZZO LISTINO (IVA ESCLUSA)
G 620 (Confezione 3 pezzi)							
503847901	G 622 D	VERDE	DOPPIO	10	16	MORBIDO	368,00 €
503847902	G 623 S	VERDE	SINGOLO	10	20	MORBIDO	264,00 €
503847903	G 623 D	VERDE	DOPPIO	10	20	MORBIDO	368,00 €
503847904	G 624 S	VERDE	SINGOLO	10	30	MORBIDO	264,00 €
503847905	G 624 D	VERDE	DOPPIO	10	30	MORBIDO	368,00 €
503847906	G 625 S	VERDE	SINGOLO	10	50	MORBIDO	264,00 €
503847907	G 625 D	VERDE	DOPPIO	10	50	MORBIDO	368,00 €
503847908	G 627 S	VERDE	SINGOLO	10	100	MORBIDO	264,00 €
503847909	G 627 D	VERDE	DOPPIO	10	100	MORBIDO	368,00 €
G 640 (Confezione 3 pezzi)							
503883401	G 643 S	GRIGIO	SINGOLO	10	20	MEDIO	264,00 €
503883402	G 643 D	GRIGIO	DOPPIO	10	20	MEDIO	368,00 €
503883403	G 644 S	GRIGIO	SINGOLO	10	30	MEDIO	264,00 €
503883404	G 644 D	GRIGIO	DOPPIO	10	30	MEDIO	368,00 €
503883405	G 645 S	GRIGIO	SINGOLO	10	50	MEDIO	264,00 €
503883406	G 645 D	GRIGIO	DOPPIO	10	50	MEDIO	368,00 €
503883407	G 647 S	GRIGIO	SINGOLO	10	100	MEDIO	264,00 €
503883408	G 647 D	GRIGIO	DOPPIO	10	100	MEDIO	368,00 €
G 670 (Confezione 3 pezzi)							
503885501	G 673 S	ORO	SINGOLO	10	20	DURO	264,00 €
503885502	G 673 D	ORO	DOPPIO	10	20	DURO	368,00 €
503885503	G 674 S	ORO	SINGOLO	10	30	DURO	264,00 €
503885504	G 674 D	ORO	DOPPIO	10	30	DURO	368,00 €

GOLD
SILVER



GUIDA ALLE APPLICAZIONI

PRODOTTO	ELITE-GRIND G 1400					VARI-GRIND G 600			PCD
	G 1410	G 1420	G 1440	G 1470	G 1480	G 620	G 640	G 670	
RIMOZIONE - MATERIALE									
Collanti ceramici porosi	-	-	-	•••	••	-	-	•••	•••
Collanti ceramici in simil plastica	-	-	•••	-	••	-	•••	-	•••
Colle viniliche*	•	••	•••	•	•	••	•••	•	-
Vernici e rivestimenti epossidici sottili (<2 mm)	•	••	•••	•	•	••	•••	•	-
Rivestimenti epossidici spessi (15 - 40 mm)	-	•	•••	•	•	•	•••	•	•••
MOLATURA - MATERIALE									
Calcestruzzo danneggiato dalla pioggia	-	-	-	••	•••	-	•	••	•
Calcestruzzo morbido	-	-	-	•••	••	-	•••	•••	••
Calcestruzzo medio-duro	-	-	•••	-	••	-	•••	-	-
Calcestruzzo duro	•••	•••	-	-	-	•••	-	-	-
Calcestruzzo semi lucidato	•••	•••	-	-	-	•••	-	-	-
ATTREZZATURA RACCOMANDATA	PG 820 - PG 820 RC - PG 680 - PG 680 RC - PG 530					PG 450 - PG 400 - PG 280			

••• = Ottimale •• = Buono • = Accettabile = Sconsigliato



Serie placchette consigliate per levigatrice PG 280

PLACCHETTE DIAMANTATE PER LEVIGATRICI

* Gli utensili per questa applicazione devono essere scelti in funzione del tipo di calcestruzzo che fa da fondo al rivestimento da rimuovere. Husqvarna consiglia di iniziare con un legante più duro (G1470 o G 1450) e passare a un legante più morbido se il risultato non dovesse essere soddisfacente.

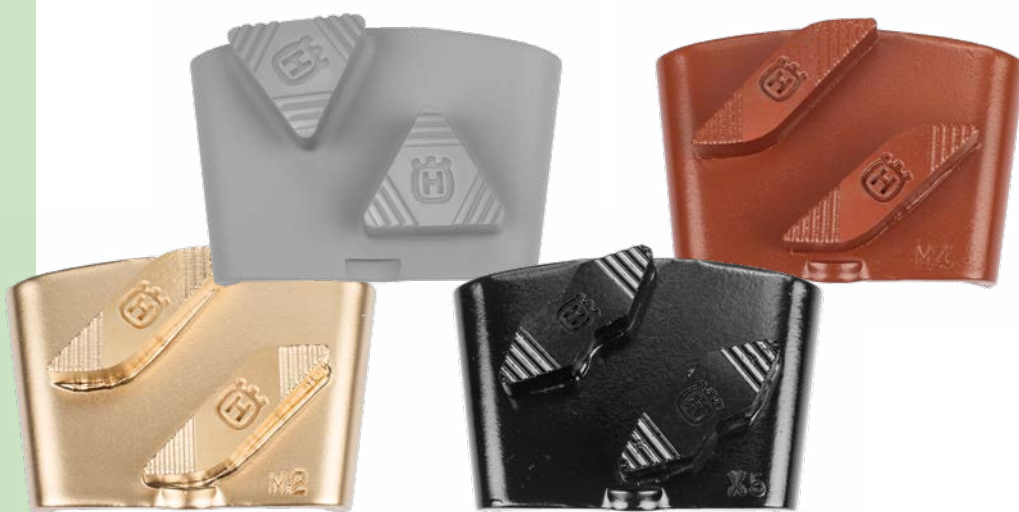

SISTEMA EZ



PLACCHETTE DIAMANTATE PER LEVIGATRICI - SISTEMA EZ

CODICE	DENOMINAZIONE	COLORE	SINGOLO/ DOPPIO	GRANA	PREZZO LISTINO (IVA ESCLUSA)
Serie EZ S - Per calcestruzzo abrasive (Confezione 3 pezzi)					
598882002	EZ S2	ORO	DOPPIO	25	366,00 €
598882102	EZ S3	GRIGIO	DOPPIO	40	366,00 €
598882202	EZ S4	MARRONE	DOPPIO	80	366,00 €
598882302	EZ S5	NERO	DOPPIO	150	366,00 €
Serie EZ M - Per calcestruzzo di media durezza (Confezione 3 pezzi)					
598882402	EZ M2	ORO	DOPPIO	25	366,00 €
598882401	EZ M2	ORO	SINGOLO	25	198,00 €
598882502	EZ M3	GRIGIO	DOPPIO	40	366,00 €
598882501	EZ M3	GRIGIO	SINGOLO	40	198,00 €
598882602	EZ M4	MARRONE	DOPPIO	80	366,00 €
598882601	EZ M4	MARRONE	SINGOLO	80	198,00 €
598882702	EZ M5	NERO	DOPPIO	150	366,00 €
598882701	EZ M5	NERO	SINGOLO	150	198,00 €
Serie EZ H - Per calcestruzzo duro (Confezione 3 pezzi)					
598883202	EZ H2	ORO	DOPPIO	25	366,00 €
598883201	EZ H2	ORO	SINGOLO	25	198,00 €
598883302	EZ H3	GRIGIO	DOPPIO	40	366,00 €
598883301	EZ H3	GRIGIO	SINGOLO	40	198,00 €
598883402	EZ H4	MARRONE	DOPPIO	80	366,00 €
598883401	EZ H4	MARRONE	SINGOLO	80	198,00 €
598883502	EZ H5	NERO	DOPPIO	150	366,00 €
598883501	EZ H5	NERO	SINGOLO	150	198,00 €
Serie EZ X - Per calcestruzzo estremamente duro (Confezione 3 pezzi)					
598884002	EZ X2	ORO	DOPPIO	25	341,00 €
598884001	EZ X2	ORO	SINGOLO	25	181,00 €
598884102	EZ X3	GRIGIO	DOPPIO	40	341,00 €
598884101	EZ X3	GRIGIO	SINGOLO	40	181,00 €
598884202	EZ X4	MARRONE	DOPPIO	80	341,00 €
598884201	EZ X4	MARRONE	SINGOLO	80	181,00 €
598884302	EZ X5	NERO	DOPPIO	150	341,00 €
598884301	EZ X5	NERO	SINGOLO	150	181,00 €
Serie EZ XX - Per calcestruzzo estremamente duro (Confezione 3 pezzi)					
598884802	EZ XX2	ORO	DOPPIO	25	341,00 €
598884801	EZ XX2	ORO	SINGOLO	25	181,00 €
598884902	EZ XX3	GRIGIO	DOPPIO	40	341,00 €
598884901	EZ XX3	GRIGIO	SINGOLO	40	181,00 €
598885002	EZ XX4	MARRONE	DOPPIO	80	341,00 €
598885001	EZ XX4	MARRONE	SINGOLO	80	181,00 €

HUSQVARNA SERVICE CONTRACTS

BENEFICI: PROTEZIONE

Pianificando ed eseguendo gli intervalli di manutenzione raccomandati da Husqvarna vi assicurate che la vostra macchina sia sempre pronta all'azione, una lunga vita operativa e contribuisce anche a mantenere un valore residuo più elevato.

MINIMIZZARE I TEMPI DI FERMO, MASSIMIZZARE I RISULTATI

Un contratto di manutenzione vi offre macchine sempre affidabili in grado di portare a termine i lavori ed un alto livello di protezione contro le spese impreviste.

NOLEGGIO SENZA PENSIERI

Manutenzione ordinaria e straordinaria anche in caso di rotture accidentali.



ESTENSIONE
DI GARANZIA



MANUTENZIONE
ORDINARIA

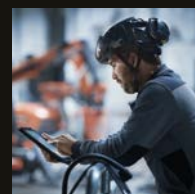

MANUTENZIONE
RIPARAZIONE

Copyright © 2023 Husqvarna AB (publ). All rights reserved. Husqvarna and other product and feature marks are trademarks.



 **Husqvarna**[®]

Husqvarna Italia S.p.A. - Construction Products
Via del Lavoro, 2 - Erba (CO) - Tel. 031 414 7700 - info.edilizia@husqvarnagroup.com
www.husqvarnaconstruction.com/it

Ci riserviamo il diritto di apportare modifiche senza preavviso alla tecnologia, alle specifiche ed ai prezzi.